

A man in a dark suit stands with his back to the camera, looking out a large window at a city skyline. The scene is dimly lit, suggesting dusk or dawn. The text 'OFFICE SOLUTION' is overlaid in large, white, outlined letters across the middle of the image.

OFFICE SOLUTION

WORKING	10
MEETING	46
PROGETTO OPEN SPACE	60
PROGETTO UPTOWN	72
ACCESSORI	84
SEDIE	92
IDENTITY CARD	102

Workplaces must be healthy, functional spaces that accommodate people whose task is to improve operational and administrative efficiency. Pratico Office by Zalf provides new space, new materials and new work environments that can contribute to improving creativity and aiding the concentration of each individual, to the advantage of group interaction and inter personal harmony that bring to the fore a world that reacts to change with enthusiasm and energy.

Les lieux de travail doivent pouvoir accueillir dans un espace fonctionnel et de bien-être les personnes qui devront s'attacher à améliorer l'efficacité opérationnelle et directionnelle. Le Pratico Office de Zalf offre de nouveaux espaces, de nouveaux matériaux, de nouvelles ambiances de travail pour améliorer la créativité, pour aider la concentration de chacun, pour augmenter l'interaction du groupe, la syntonie interpersonnelle et pour faire émerger le portrait d'un monde qui réagit au changement avec enthousiasme et énergie.

Arbeitsplätze müssen für Menschen, die im Betrieb und in leitenden Positionen Leistung erbringen, ein funktionaler Raum sein, der Wohlbefinden schafft. Pratico Office von Zalf bietet neue Räume, neue Materialien, neue Arbeitsplätze, um die Kreativität zu verbessern, die Konzentration der einzelnen Mitarbeiter zu fördern, Gruppeninteraktion und interpersonelle Beziehungen zu stärken, sowie das Bild einer Welt zu vermitteln, die auf Veränderungen mit Enthusiasmus und Energie reagiert.

Los lugares de trabajo deben poder acoger en un espacio funcional y de bienestar a las personas que deberán encargarse de mejorar la eficiencia operativa y directiva. Pratico Office de Zalf ofrece nuevos espacios, nuevos materiales, nuevos ambientes de trabajo para mejorar la creatividad, para ayudar la concentración individual, para aumentar la interacción grupal, la sintonía interpersonal y hacer aparecer el retrato de un mundo que reacciona al cambio con entusiasmo y energía.

OFFICE SOLUTION

design R&S Zalf e Roberto Gobbo

I luoghi del lavoro devono poter accogliere in uno spazio funzionale e di benessere le persone che dovranno occuparsi di affermare l'efficienza operativa e direzionale. Pratico Office di Zalf offre nuovi spazi, nuovi materiali, nuovi ambienti di lavoro per migliorare la creatività, per aiutare la concentrazione dei singoli, per aumentare l'interazione di gruppo, la sintonia interpersonale e far emergere il ritratto di un mondo che reagisce al cambiamento con entusiasmo ed energia.

P01

**GAMBA
A PORTALE**

Portal leg
Pied à portique
Kufengestell
Pata en forma de portal



P02

**GAMBA
A TELAIO**

Frame leg
Pied structure
4-Fuß-Gestell
Pata enmarcada



P03

**GAMBA
PIENA**

Full leg
Pied plein
Wangengestell
Pata llena



P04

**GAMBA TERMINALE
CON CONTENIMENTO**

End leg with storage unit
Pied terminal avec rangement
Seitengestell mit Staufächern
Pata terminal con elemento contenedor



P05

**GAMBA TERMINALE
CON CASSETTI**

End leg with drawers
Pied terminal avec tiroirs
Seitengestell mit Schubkästen
Pata terminal con cajones



pratico office

Il sistema Pratico Office ha un approccio al design incentrato sull'individuo: l'ampia gamma di possibilità ergonomiche delle cinque gambe delle scrivanie offre infatti il maggior benessere possibile.

The design approach of the Pratico Office system centres on the individual: a wide range of ergonomic solutions for the five desk legs provide the greatest possible wellbeing.

Le système Pratico Office a une approche du design centrée sur l'individu: la vaste gamme de possibilités ergonomiques des cinq pieds des bureaux offre en effet le meilleur bien-être possible.

Das Design des Systems Pratico Office setzt am Individuum an: die umfangreiche Auswahl an ergonomischen Möglichkeiten der fünf Schreibtischgestelle bietet mehr Möglichkeit für Wohlbefinden.

El sistema Pratico Office se acerca al diseño basado en el individuo: en realidad la amplia gama de posibilidades ergonómicas de las cinco patas de los escritorios ofrece el máximo bienestar posible.

working
management
business
meeting
reception

working

SCRIVANIE CON GAMBA A PORTALE

P01

Desks with portal leg
Bureaux avec pied à portique
Schreibtische mit Kufengestell
Escritorios con pata en forma de portal



Z572 pag.26



Z699 pag.30



Z695 pag.34



Z576 pag.36

SCRIVANIE CON GAMBA A TELAIO

P02

Desks with frame leg
Bureaux avec pied structure
Schreibtische mit 4-Fuß-Gestell
Escritorios con pata enmarcada



Z683 pag.14

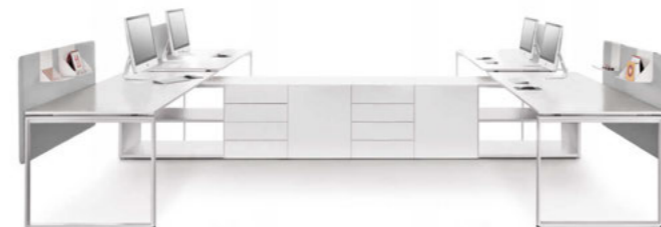

Z571 pag.18



Z573 pag.22

SCRIVANIE CON GAMBA PIENA

P03

Desks with full leg
Bureaux avec pied plein
Schreibtische mit Wangengestell
Escritorios con pata llena



Z577 pag.38



Z692 pag.40



Z575 pag.42

SCRIVANIE CON GAMBA TERMINALE CON CONTENIMENTO

P04

Desks with end leg with storage unit
Bureaux avec pied terminal avec rangement
Schreibtische mit Seitengestell mit Staufächern
Escritorios con pata terminal con elemento contenedor



Z693 pag.44

SCRIVANIE CON GAMBA TERMINALE CON CASSETTI

P05

Desks with end leg with drawers
Bureaux avec pied terminal avec tiroirs
Schreibtische mit Seitengestell mit Schubkästen
Escritorios con pata terminal con cajones



Z684 pag.12

meeting

TAVOLI RIUNIONE

Meeting tables
Tables réunion
Konferenztische
Mesas de reunión



Z685 pag.50



Z579 pag.52



Z578 pag.56

chairs

SEDIE

Chairs
Chaises
Stühle
Sillas



CALLA pag.92



CRONO pag.94



FLEXA pag.96



ECO pag.98



OTAVO pag.100



POCKET pag.100



Scrivania con gamba con cassetti P05 e in appoggio
 a Link System. Sedia Flexa. Armadio Monopoli.
 Desk with P05 leg with drawers, combined with
 Link System. Flexa chair. Monopoli cabinet.
 Bureau avec pied avec tiroirs P05 et posé sur
 Link System. Chaise Flexa. Armoire Monopoli.
 Schreibtisch mit Seitengestell mit Schubkästen P05
 aufgesetzt auf Link System. Stuhl Flexa. Schrank Monopoli.
 Escritorio con pata con cajones P05 y de apoyo
 en Link System. Silla Flexa. Armario Monopoli.

Z684

SCRIVANIE MULTIPLE CON GAMBA TERMINALE CON CASSETTI P05

Multiple desks with P05 end leg with drawers
 Bureaux multiple avec pied terminal avec tiroirs P05
 Schreibtischkombinationen mit Seitengestell mit Schubkästen P05
 Escritorios múltiples con pata terminal con cajones P05

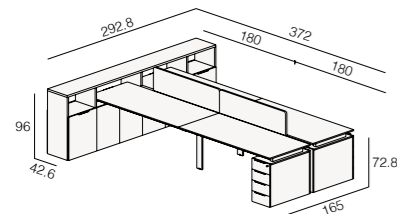

LINK SYSTEM

Libreria bifacciale
 in melaminico perla.
 Double face bookcase
 in pearl melamine.
 Bibliothèque double-face
 en mélaminé perle.
 Doppelseitiges Bücherregal
 aus Melamin in Perle.
 Librería de dos caras
 de melamina perla.

SCREEN

Screen sospeso
 in tessuto Xtreme.
 Suspended screen
 in Xtreme fabric.
 Screen suspendu
 en tissu Xtreme.
 Hängender Sichtschutz
 aus Stoff Xtreme.
 Screen colgante
 de tejido Xtreme.

FLEXA

Sedia con sedile imbottito
 e schienale in co-polimero.
 Chair with padded seat
 and co-polymer backrest.
 Chaise avec siège rembourré
 et dossier en copolymère.
 Stuhl mit gepolstertem Sitz und
 Rückenlehne aus Copolymer.
 Silla con asiento mullido
 y respaldo de copolimero.

SCRIVANIA

Gamba terminale con cassetti P05
 e piano in melaminico bianco.
 P05 end leg with drawers
 and white melamine top.
 Pied terminal avec tiroirs P05
 et plateau en mélaminé blanc.
 Seitengestell mit Schubkästen P05
 und Platte aus Melamin in Weiß.
 Pata terminal con cajones P05
 y tablero de melamina blanco.

Z683

SCRIVANIE CON GAMBA A TELAIO P02

Desks with P02 frame leg
Bureaux avec pied structure P02
Schreibtische mit 4-Fuß-Gestell P02
Escritorios con pata enmarcada P02

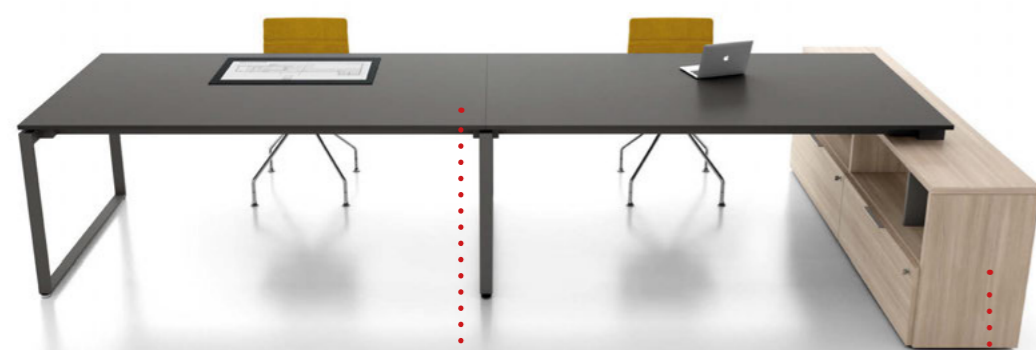
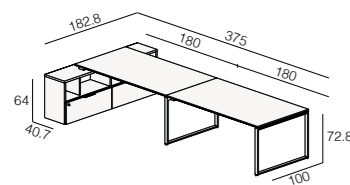

SCRIVANIA

Gamba P02 in metallo grafite.
Piano in melaminico ardesia.
P02 leg in graphite metal.
Slate melamine top.
Pied P02 en métal graphite.
Plateau en mélaminé ardoise.
Gestell P02 aus Metall in Graphit.
Platte aus Melamin in Schiefer.
Pata P02 de metal grafito. Tablero de melamina color pizarra.

LINK SYSTEM

Libreria in termostrutturato olmo sand NT e melaminico ardesia.
Bookcase in thermostructured elm sand NT and slate melamine.
Bibliothèque en thermostructuré orme sand NT et mélaminé ardoise.
Bücherregal mit thermostrukturierter Oberfläche in Ulme Sand NT und aus Melamin in Schiefer.
Librería de termoestructurado de olmo sand NT y melamina color pizarra.



Scrivania e libreria Link System. Boiserie Picà con elementi da aggancio a giorno e mensole dotate di luce Led. Armadio ad angolo Monopoli.
Link System desk and bookcase. Picà boiserie with open hook-on units and shelves with LED lighting. Monopoli corner cabinet.
Bureau et bibliothèque Link System. Boiserie Picà avec éléments à accrocher ouverts et tablettes dotées de lumière Led. Armoire d'angle Monopoli.
Schreibtisch und Bücherregal Link System. Wandpaneel Picà mit offenen Elementen zum Einhängen und Borden mit LED-Beleuchtung. Eckschrank Monopoli.
Escritorio y librería Link System. Boiserie Picà con elementos de enganche abiertos y baldas provistas de luz de Led. Armario angular Monopoli.



Scrivania con gamba a telaio P02 e in appoggio a libreria Link System.
 Sedie Eco. Libreria Link System con ante ed elementi Freebox.
 Desk with P02 frame leg, combined with a Link System bookcase.
 Eco chairs. Link System bookcase with doors and Freebox units.
 Bureau avec pied structure P02 et posé sur la bibliothèque Link System.
 Chaises Eco. Bibliothèque Link System avec portes et éléments Freebox.
 Schreibtische mit 4-Fuß-Gestell P02 aufgesetzt auf Bücherregal Link System.
 Stühle Eco. Bücherregal Link System mit Türen und Elementen Freebox.
 Escritorio con pata enmarcada P02 y de apoyo en librería Link System.
 Sillas Eco. Librería Link System con puertas y elementos Freebox.

Z571

SCRIVANIE MULTIPLE CON GAMBA A TELAIO P02

Multiple desks with P02 frame leg
 Bureaux multiple avec pied structure P02
 Schreibtischkombinationen mit 4-Fuß-Gestell P02
 Escritorios múltiples con pata enmarcada P02

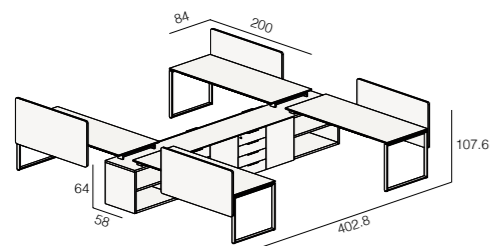

SCREEN

Screen sospeso in tessuto Xtreme con accessori da aggancio.
 Suspended screen in Xtreme fabric with hook-on accessories.
 Screen suspendu en tissu Xtreme avec accessoires à accrocher.
 Hängender Sichtschutz aus Stoff Xtreme mit Zubehör zum Einhängen.
 Screen colgante de tejido Xtreme con accesorios de enganche.

LINK SYSTEM

Libreria bifacciale in melaminico bianco.
 White melamine double face bookcase.
 Bibliothèque double-face en mélaminé blanc.
 Doppelseitiges Bücherregal aus Melamin in Weiß.
 Librería de dos caras de melamina blanca.

ECO

Sedia con sedile imbottito e schienale in tessuto Spider.
 Chair with padded seat and Spider fabric backrest.
 Chaise avec siège rembourré et dossier en tissu Spider.
 Stuhl mit gepolsterem Sitz und Rückenlehne aus Stoff Spider.
 Silla con asiento mullido y respaldo de tejido Spider.

SCRIVANIA

Gamba P02 in metallo bianco.
 Piano in melaminico bianco.
 P02 white metal leg.
 White melamine top.
 Pied P02 en métal blanc.
 Plateau en mélaminé blanc.
 Gestell P02 aus Metall in Weiß.
 Platte aus Melamin in Weiß.
 Pata P02 de metal blanco. Tablero de melamina color blanco.



Scrivanie con gamba a telaio P02.
 Sedie Otavo. Librerie Link System.
 Desks with P02 frame leg. Otavo
 chairs. Link System bookcases.
 Bureaux avec pied structure P02.
 Chaise Otavo. Bibliothèques Link System.
 Schreibtische mit 4-Fuß-Gestell P02.
 Stühle Otavo. Bücherregale Link System.
 Escritorios con pata con enmarcada P02.
 Sillas Otavo. Librerías Link System.

Z573

SCRIVANIE CON GAMBA A TELAIO P02

Desks with P02 frame leg
Bureaux avec pied structure P02
Schreibtische mit 4-Fuß-Gestell P02
Escritorios con pata enmarcada P02

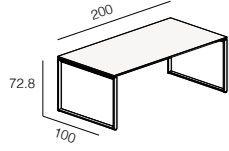

OTAVO

Sedia con sedile imbottito e schienale in rete Vega.
Chair with padded seat and Vega mesh backrest.
Chaise avec siège rembourré et dossier en grillage Vega.
Stuhl mit gepolsterem Sitz und Rückenlehne aus Netzmaterial Vega.
Silla con asiento mullido y respaldo de red Vega.

SCRIVANIA

Gamba P02 in metallo bianco.
Piano in melaminico bianco.
P02 white metal leg.
White melamine top.
Pied P02 en métal blanc.
Plateau en mélaminé blanc.
Gestell P02 aus Metall in Weiß.
Platte aus Melamin in Weiß.
Pata P02 de metal blanco.
Tablero de melamina blanco.





Scrivania con piano sagomato e con gamba a portale P01. Sedie Otavo. Boiserie Picà Minus.
 Desk with shaped top and P01 portal leg.
 Otavo chairs. Picà Minus boiserie.
 Bureau avec plateau façonné et avec pied à portique P01. Chaises Otavo. Boiserie Picà Minus.
 Schreibtisch mit Freiformplatte und Kufengestell P01. Stühle Otavo. Wandpaneel Picà Minus.
 Escritorio con tablero perfilado y con pata en forma de portal P01. Sillas Otavo. Boiserie Picà Minus.

Z572

SCRIVANIE MULTIPLE CON PIANO SAGOMATO E GAMBA A PORTALE P01

Multiple desks with shaped top and P01 portal leg
 Bureaux multiple avec plateau façonné et pied à portique P01
 Schreibtischkombinationen mit Freiformplatte und Kufengestell P01
 Escritorios múltiples con tablero perfilado y pata en forma de portal P01

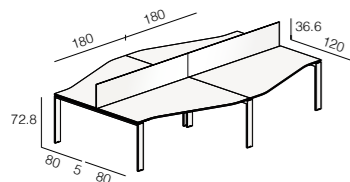

CASSETTIERE

Cassettiere a tre cassette
 in metallo "0" chimico.
 Set of three anodised
 metal drawers.
 Meubles à trois tiroirs en
 métal "0" chimique.
 Schubkastenelemente
 mit drei Schubkästen aus
 Metall C-Null eloxiert.
 Cajoneras de tres cajones
 de metal "0" químico.

SCREEN

Screen sospeso in vetro acidato.
 Suspended acid etched glass screen.
 Screen suspendu en verre acidifié.
 Hängender Sichtschutz aus geätztem Glas.
 Screen colgante de cristal tratado al ácido.

OTAVO

Sedia con sedile imbottito
 e schienale in rete Vega.
 Chair with padded seat
 and Vega mesh backrest.
 Chaise avec siège rembourré
 et dossier en grillage Vega.
 Stuhl mit gepolstertem Sitz und
 Rückenlehne aus Netzmaterial Vega.
 Silla con asiento mullido
 y respaldo de red Vega.

SCRIVANIA

Gamba P01 in metallo "0" chimico.
 Piano sagomato in melaminico perla.
 P01 anodised metal leg.
 Pearl melamine shaped top.
 Pied P01 en métal "0" chimique.
 Plateau façonné en mélaminé perle.
 Gestell P01 aus Metall C-Null eloxiert.
 Freiformplatte aus Melamin in Perle.
 Pata P01 de metal "0" químico.
 Tablero perfilado de melamina perla.



Scrivania con gamba a portale P01.
 Sedia Calla. Libreria Link System.
 Desk with P01 portal leg. Calla
 chairs. Link System bookcase.
 Bureau avec pied à portique P01.
 Chaises Calla. Bibliothèque Link System.
 Schreibtisch mit Kufengestell P01.
 Stuhl Calla. Bücherregal Link System.
 Escritorio con pata en forma de portal
 P01. Sillas Calla. Librería Link System.

Z699

SCRIVANIA DOPPIA CON GAMBA A PORTALE P01

Double desk with P01 portal leg

Bureau double avec pied à portique P01

Doppelter Schreibtisch mit Kufengestell P01

Escritorio doble con pata en forma de portal P01

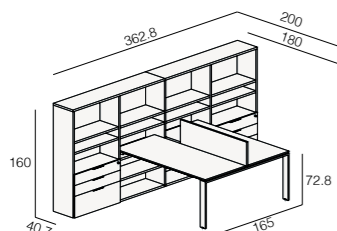

FLEXA

Sedia con sedile imbottito e schienale in co-polimero.
Chair with padded seat and co-polymer backrest.
Chaise con siège rembourré et dossier en copolymère.
Stuhl mit gepolstertem Sitz und Rückenlehne aus Copolymer.
Silla con asiento mullido y respaldo de copolimero.

SCRIVANIA

Gamba P01 in metallo grafito.
Piano in melaminico ardesia.
P01 graphite metal leg.
Slate melamine top.
Pied P01 en métal graphite.
Plateau en mélaminé ardoise.
Gestell P01 aus Metall in Graphit.
Platte aus Melamin in Schiefer.
Pata P01 de metal grafito. Tablero de melamina color pizarra.

SCREEN

Screen sospeso in melaminico verde eden.
Eden green melamine suspended screen.
Screen suspendu en mélaminé vert eden.
Hängender Sichtschutz aus Melamin in Grün Eden.
Screen colgante de melamina verde eden.

LINK SYSTEM

Libreria in melaminico ardesia.
Slate melamine bookcase.
Bibliothèque en mélaminé ardoise.
Bücherregal aus Melamin in Schiefer.
Librería de melamina color pizarra.



Scrivania con gamba a portale P01 e sedia Calla. Libreria Link System con piano top sp.5 cm e pannellatura Tex; elementi pensili Puzzle12.
 Desk with P01 portal leg and Calla chair. Link System bookcase with 5cm thick top and Tex panelling; Puzzle12 wall units.
 Bureau avec pied à portique P01 et chaise Calla. Bibliothèque Link System avec plateau top ép. 5 cm et lambris Tex; éléments hauts Puzzle12.
 Schreibtisch mit Kufengestell P01 und Stuhl Calla. Bücherregal Link System mit Deckplatte St. 5 cm und Wandverkleidung Tex; Hängeelemente Puzzle12.
 Escritorio con pata en forma de portal P01 y silla Calla. Librería Link System con sobre de 5 cm de esp. y serie de paneles Tex; elementos colgantes Puzzle12.

Z695

SCRIVANIE MULTIPLE CON PIANO DI SERVIZIO E GAMBA A PORTALE P01

Multiple desks with service top and P01 portal leg

Bureaux multiple avec plateau de service et pied à portique P01

Schreibtischkombinationen mit Ablageplatte und Kufengestell P01

Escritorios múltiples con tablero de trabajo y pata en forma de portal P01

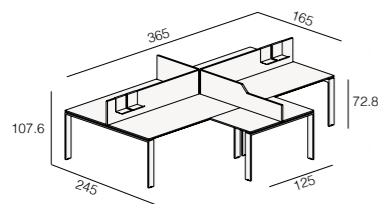

SCREEN

Screen sospeso in melaminico cashmere.
Cashmere melamine suspended screen.
Screen suspendu en mélaminé cashmere.
Hängender Sichtschutz aus Melamin in Kaschmir.
Screen colgante de melamina cashmere.

SCRIVANIA

Scrivanie con gamba P01 in metallo bianco. Piano melaminico bianco.
Desks with P01 white metal leg. White melamine top.
Bureaux avec pied P01 en métal blanc. Plateau mélaminé blanc.
Schreibtische mit Kufengestell P01 aus Metall in Weiß. Platte aus Melamin in Weiß.
Escritorios con pata P01 de metal blanco. Tablero de melamina blanco.

CALLA

Sedia con sedile e schienale in rete.
Chair with mesh seat and backrest.
Chaise avec siège et dossier en grillage.
Stuhl mit Rückenlehne und Sitz aus Netzmaterial.
Silla con asiento y respaldo de red.

Z576

TAVOLO DIREZIONALE CON GAMBA A PORTALE P01

Executive table with P01 portal leg

Table directionnelle avec pied à portique P01

Chefschreibtisch mit Kufengestell P01

Mesa direccional con pata en forma de portal P01

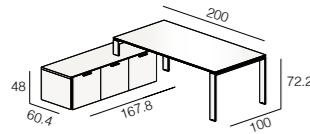

CALLA

Sedia con sedile e schienale in rete.
Chair with mesh seat and backrest.
Chaise avec siège et dossier en grillage.
Stuhl mit Sitz und Rückenlehne aus Netzmaterial.
Silla con asiento y respaldo de red.

TAVOLO DIREZIONALE

Gamba P01 in metallo grafite. Elementi Link System in termostrutturato olmo cortex NT. Piano in vetro nero lucido.
P01 graphite metal leg. Link System units in thermostructured elm cortex NT. Glossy black glass top.
Pied P01 en métal graphite. Éléments Link System en thermostructuré orme cortex NT. Plateau en verre noir brillant.
Gestell P01 aus Metall in Graphit. Elemente Link System mit thermostrukturierter Oberfläche in Ulme Cortex NT.
Platte aus glänzendem Glas in Schwarz.
Pata P01 de metal grafito. Elementos Link System de termoestructurado de olmo cortex NT. Tablero de cristal negro brillante.



Tavolo direzionale con sedia Calla. Piano di servizio con gamba a portale P01 ed elementi Link System.
Executive table with Calla chair. Service top with P01 portal leg and Link System units.
Table directionnelle avec chaise Calla. Plateau de service avec pied à portique P01 et éléments Link System.
Chefschreibtisch mit Stuhl Calla. Ablagefläche mit Kufengestell P01 und Elemente Link System.
Mesa direccional con silla Calla. Tablero de trabajo con pata en forma de portal P01 y elementos Link System.



Tavolo direzionale con sedia Calla. Libreria Link System con ante vetro. Pannellatura per TV e contenimento sospeso Monopoli.
 Executive table with Calla chairs. Link System bookcase with glass doors. Monopoli panelling for TV and suspended storage unit.
 Table directionnelle avec chaises Calla. Bibliothèque Link System avec portes verre. Lambris pour TV et rangement suspendu Monopoli.
 Chefschreibtisch mit Stühlen Calla. Bücherregal Link System mit Glstüren. Wandverkleidung für Fernseher und hängendes Stauraumelement Monopoli.
 Mesa direccional con silla Calla. Librería Link System con puertas de cristal. Serie de paneles para TV y elemento contenedor colgante Monopoli.

Z577

TAVOLO DIREZIONALE CON GAMBA PIENA P03

Executive table with P03 full leg
 Table directionnelle avec pied plein P03
 Chefschreibtisch mit Wangengestell P03
 Mesa direccional con pata llena P03

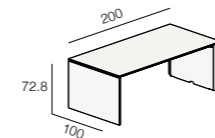

CASSETTIERA

Cassettiera su ruote in termostrutturato olmo cortex NT.
 Set of drawers on wheels, in thermostructured elm cortex NT.
 Meuble à tiroirs sur roulettes en thermostructuré orme cortex NT.
 Schubkastenelement auf Rollen mit thermostrukturierter Oberfläche in Ulme Cortex NT.
 Cajonera sobre ruedas de termoestructurado de olmo cortex NT.

TAVOLO DIREZIONALE

Gamba P03 e piano in termostrutturato olmo cortex NT.
 P03 leg and top in thermostructured elm cortex NT.
 Pied P03 et plateau en thermostructuré orme cortex NT.
 Gestell P03 und Platte mit thermostrukturierter Oberfläche in Ulme Cortex NT.
 Pata P03 y tablero de termoestructurado de olmo cortex NT.

CALLA

Sedia con sedile e schienale in rete.
 Chair with mesh seat and backrest.
 Chaise avec siège et dossier en grillage.
 Stuhl mit Sitz und Rückenlehne aus Netzmaterial.
 Silla con asiento y respaldo de red.

Z692

TAVOLO DIREZIONALE CON GAMBA PIENA P03

Executive table with P03 full leg
Table directionnelle avec pied plein P03
Chefschreibtisch mit Wangengestell P03
Mesa direccional con pata llena P03

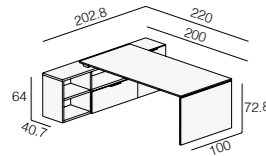

TAVOLO DIREZIONALE

Gamba P03 e piano in termostrutturato olmo cortex NT.
P03 leg and top in thermostructured elm cortex NT.
Pied P03 et plateau in termostructuré orme cortex NT.
Gestell P03 und Platte mit thermostrukturierter Oberfläche in Ulme Cortex NT.
Pata P03 y tablero de termoestructurado de olmo cortex NT.

LINK SYSTEM

Libreria bifacciale in melaminico ardesia.
Double face bookcase in slate melamine.
Bibliothèque double-face en mélaminé ardoise.
Doppelseitiges Bücherregal aus Melamin in Schiefer.
Librería de dos caras de melamina color pizarra.



Tavolo direzionale con sedia Crono e sedia Calla. Libreria Link System con ante vetro Teca.
Executive table with Crono chair and Calla chairs.
Link System bookcase with Teca glass doors.
Table directionnelle avec chaise Crono et chaises Calla.
Bibliothèque Link System avec portes vitrées Teca.
Chefschreibtisch mit Stuhl Crono und Stühlen Calla.
Bücherregal Link System mit Glastüren Teca.
Mesa direccional con silla Crono y sillas Calla.
Librería Link System con puertas de cristal Teca.



Tavolo direzionale con sedia Crono. Libreria Link System con ante in vetro e colonna a giorno. Classificatori Monopoli.
 Executive table with Crono chair. Link System bookcase with glass doors and open column. Monopoli filing cabinets.
 Table directionnelle avec chaise Crono. Bibliothèque Link System avec portes vitrées et colonne ouverte. Classeurs Monopoli.
 Chefschreibtisch mit Stuhl Crono. Bücherregal Link System mit Glastüren und offenem Hochschrank. Aktenschränke Monopoli.
 Mesa direccional con silla Crono. Librería Link System con puertas de cristal y columna abierta. Clasificadores Monopoli.

Z575

TAVOLO DIREZIONALE CON GAMBA PIENA P03

Executive table with P03 full leg
 Table directionnelle avec pied plein P03
 Chefschreibtisch mit Wangengestell P03
 Mesa direccional con pata llena P03

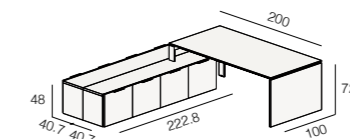

CRONO

Sedia con sedile e schienale con poggiatesta imbottiti.
 Chair with padded seat and backrest with head cushion.
 Chaise avec siège et dossier avec appui-tête rembourrés.
 Stuhl mit Sitz und Rückenlehne mit gepolsterter Kopfstütze.
 Silla con asiento y respaldo con reposacabezas mullidos.

TAVOLO DIREZIONALE

Gamba P03 e piano in termostrutturato rovere bianco a poro aperto.
 Elementi Link System in melaminico selce.
 P03 leg and top in thermostructured open pore white oak. Link System units in flint melamine.
 Pied P03 et plateau en thermostructuré chêne rouvre blanc à pore ouvert.
 Éléments Link System en mélaminé sillex.
 Gestell P03 und Platte mit thermostrukturierter Oberfläche in Eiche Weiß offenporig.
 Elemente Link System aus Melamin in Kiesel.
 Pata P03 y tablero de termoestructurado de roble blanco a poro abierto.
 Elementos Link System de melamina sillex.

Z693

SCRIVANIA CON PIANO DI SERVIZIO E GAMBA TERMINALE CON CONTENIMENTO P04

Desk with service top and P04 end leg with storage unit

Bureau avec plateau de service et pied terminal avec rangement P04

Schreibtisch mit Ablagefläche und Seitengestell mit Staufächern P04

Escritorio con tablero de trabajo y pata terminal con elemento contenedor P04

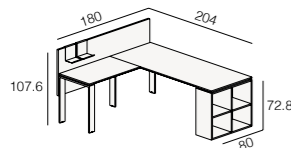

SCREEN

Screen sospeso in melaminico ardesia con accessori da aggancio.
Suspended slate melamine screen with hook-on accessories.
Screen suspendu en mélaminé ardoise avec accessoires à accrocher.
Hängender Sichtschutz aus Melamin in Schiefer mit Zubehör zum Einhängen.
Screen colgante de melamina color pizarra con accesorios de enganche.

CALLA

Sedia con sedile e schienale in pelle.
Chair with leather seat and backrest.
Chaise avec siège et dossier en cuir.
Stuhl mit Sitz und Rückenlehne aus Leder.
Silla con asiento y respaldo de piel.

SCRIVANIA

Gamba terminale con contenimento P04 e piano in melaminico perla.
P04 end leg with storage unit and top in pearl melamine.
Pied terminal avec rangement P04 et plateau en mélaminé perle.
Seitengestell mit Staufächern P04 und Platte aus Melamin in Perle.
Pata terminal con elemento contenedor P04 y tablero de melamina perla.



Scrivania con sedia Calla. Pensili G45. Piano scrittoio Minimal.
Desk with Calla chair. Wall units G45. Minimal desk top.
Bureau avec chaise Calla. Éléments hauts G45. Plateau bureau Minimal.
Schreibtisch mit Stuhl Calla. Hängeschränke G45. Schreibtischplatte Minimal.
Escritorio con silla Calla. Muebles colgantes G45. Tablero de escritorio Minimal.



PRATICO OFFICE

MEETING TABLES

Spazi di relazione e di condivisione, dove ricevere stimoli e ispirazioni e poter scambiare punti di vista e idee. Areas for relationships and problem solving, stimulating and inspiring exchanges of ideas and points of view. Espaces de communication et de partage, où recevoir des stimulations et des inspirations et pouvoir échanger des points de vue et idées. Räume, um zusammenzukommen und sich auszutauschen, in denen Anregungen und Ideen entstehen sowie Gesichtspunkte erörtert werden. Espacios de relación y compartición, donde recibir inspiraciones y poder intercambiar puntos de vista e ideas.



Tavolo riunione con gamba a portale P01.
 Libreria Domino ed elementi pensili Freedom.
 Meeting table with P01 portal leg, Domino
 bookcase and Freedom wall units.
 Table réunion avec pied à portique P01.
 Bibliothèque Domino et éléments hauts Freedom.
 Konferenztisch mit Kufengestell P01. Bücherregal
 Domino und Hängeelemente Freedom.
 Mesa de reunión con pata en forma de portal P01.
 Librería Domino y elementos colgantes Freedom.

Z685

TAVOLO RIUNIONE P.165 CON GAMBA A PORTALE P01

D.165 Meeting table with P01 portal leg
 Table réunion P.165 avec pied à portique P01
 Konferenztisch T.165 mit Kufengestell P01
 Mesa de reunión de 165 de P. con pata en forma de portal P01

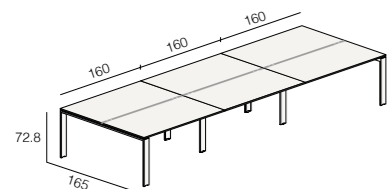

TAVOLO RIUNIONE

Gamba P01 in metallo bianco.
 Piano in melaminico bianco.
 White metal P01 leg.
 White melamine top.
 Pied P01 en métal blanc.
 Plateau en mélaminé blanc.
 Gestell P01 aus Metall in Weiß.
 Platte aus Melamin in Weiß.
 Pata P01 de metal blanco.
 Tablero de melamina blanco.

GAMBA RIENTRANTE

Gamba centrale rientrante
 P01 in metallo bianco.
 Centre recessed
 white metal P01 leg.
 Pied central rentrant
 P01 en métal blanc.
 Zurückversetztes mittleres
 Gestell P01 aus Metall in Weiß.
 Pata central escamoteable
 P01 de metal blanco.

CARTER

Carter con canala
 passacavi telescopica.
 Cover with telescopic
 cable channel.
 Carter avec canal passe-
 câbles télescopique.
 Verkleidung mit
 Teleskop-Kabelkanal.
 Cárter con canal
 pasacables telescópico.

Z579

TAVOLO RIUNIONE P.120 CON GAMBA A PORTALE P01

D.120 meeting table with P01 portal leg

Table réunion P.120 avec pied à portique P01

Konferenztisch T.120 mit Kufengestell P01

Mesa de reunión de 120 de P. con pata en forma de portal P01

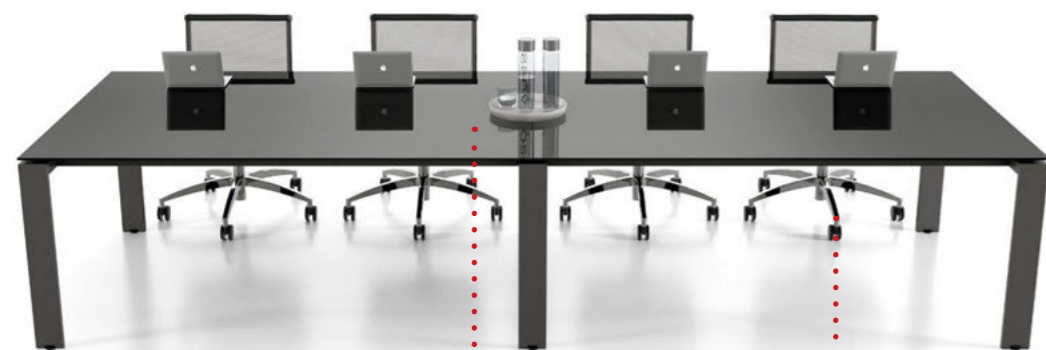
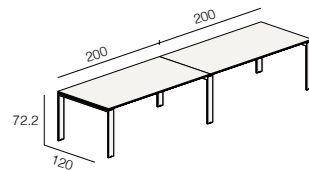

TAVOLO RIUNIONE

Gamba P01 in metallo grafite.
 Piano in vetro nero lucido.
 P01 graphite metal leg.
 Glossy black glass top.
 Pied P01 en métal graphite.
 Plateau en verre noir brillant.
 Gestell P01 aus Metall in Graphit. Platte
 aus glänzendem Glas in Schwarz.
 Pata P01 de metal grafito.
 Tablero de cristal negro brillante.

CALLA

Sedia con sedile
 e schienale in rete.
 Chair with mesh
 seat and backrest.
 Chaise avec siège
 et dossier en grillage.
 Stuhl mit Sitz
 und Rückenlehne
 aus Netzmaterial.
 Silla con asiento
 y respaldo de red.





Tavolo riunione con gamba a portale P01 e sedie Calla.
Meeting table with P01 portal leg and Calla chairs.
Table réunion avec pied à portique P01 et chaises Calla.
Konferenztisch mit Kufengestell P01 und Stühle Calla.
Mesa de reunión con pata en forma de portal P01 y sillas Calla.



Z578

TAVOLO RIUNIONE P.125 CON GAMBA A PORTALE P01

D.125 meeting table with P01 portal leg
 Table réunion P.125 avec pied à portique P01
 Konferenztisch T.125 mit Kufengestell P01
 Mesa de reunión de 125 de P. con pata en forma de portal P01

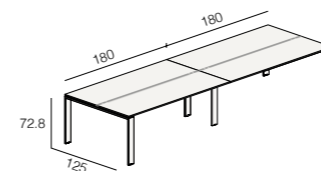

SISTEMA DI CONNESSIONE

Sistema di connessione con carter e canale passacavi telescopica.
 Connection system with cover and telescopic cable.
 Système de connexion avec carter et canal passe-câbles télescopique.
 Verbindungssystem mit Verkleidung und Teleskop-Kabelkanal.
 Sistema de conexión con cárter y canal pasacables telescópico.

TAVOLO RIUNIONE

Gamba P01 in metallo grafite.
 Piano termostrutturato olmo cortex NT.
 P01 graphite metal leg. Top in thermostructured elm cortex NT.
 Pied P01 en métal graphite. Plateau thermostructuré orme cortex NT.
 Gestell P01 aus Metall in Graphit.
 Platte mit thermostrukturierter Oberfläche in Ulme Cortex NT.
 Pata P01 de metal grafito. Tablero de termoestructurado de olmo cortex NT.

GAMBA RIENTRANTE

Gamba centrale rientrante
 P01 in metallo grafite.
 Central recessed graphite metal P01 leg.
 Pied centrale rentrant P01 en métal graphite.
 Zurückversetztes mittleres Gestell P01 aus Metall in Graphit.
 Pata central escamoteable P01 de metal grafito.



WORKING

COMMUNITY

totalworkdesign

SOCIAL

MEETING



Gli ambienti di lavoro, dove si passa il maggior tempo della giornata, devono essere confortevoli e accoglienti. Un progetto possibile con l'interazione tra Pratico Office e i mobili Zalf, le cucine Euromobil, i divani e le poltrone Désirée.

Work places where people spend a good part of their days must be comfortable and pleasant. This is made possible by the interaction between Zalf's Pratico Office and furniture items, Euromobil kitchen furniture and Désirée sofas and armchairs. Les ambiances de travail, où l'on passe la plus grande partie de la journée, doivent être confortables et accueillantes. Un projet possible avec l'interaction entre Pratico Office et les meubles Zalf, les cuisines Euromobil, les canapés et les fauteuils Désirée. Arbeitsräume, in denen man die meiste Zeit des Tages verbringt, müssen komfortabel und gemütlich sein. Ein Projekt, das durch die Interaktion von Pratico Office, Möbel Zalf, Küchen Euromobil, Sofas und Sessel Désirée möglich wird. Los ambientes de trabajo, donde se pasa la mayor parte del día, deben ser confortables y acogedores. Un proyecto posible con la interacción entre Pratico Office y los muebles de Zalf, las cocinas de Euromobil, los sofás y las butacas de Désirée.



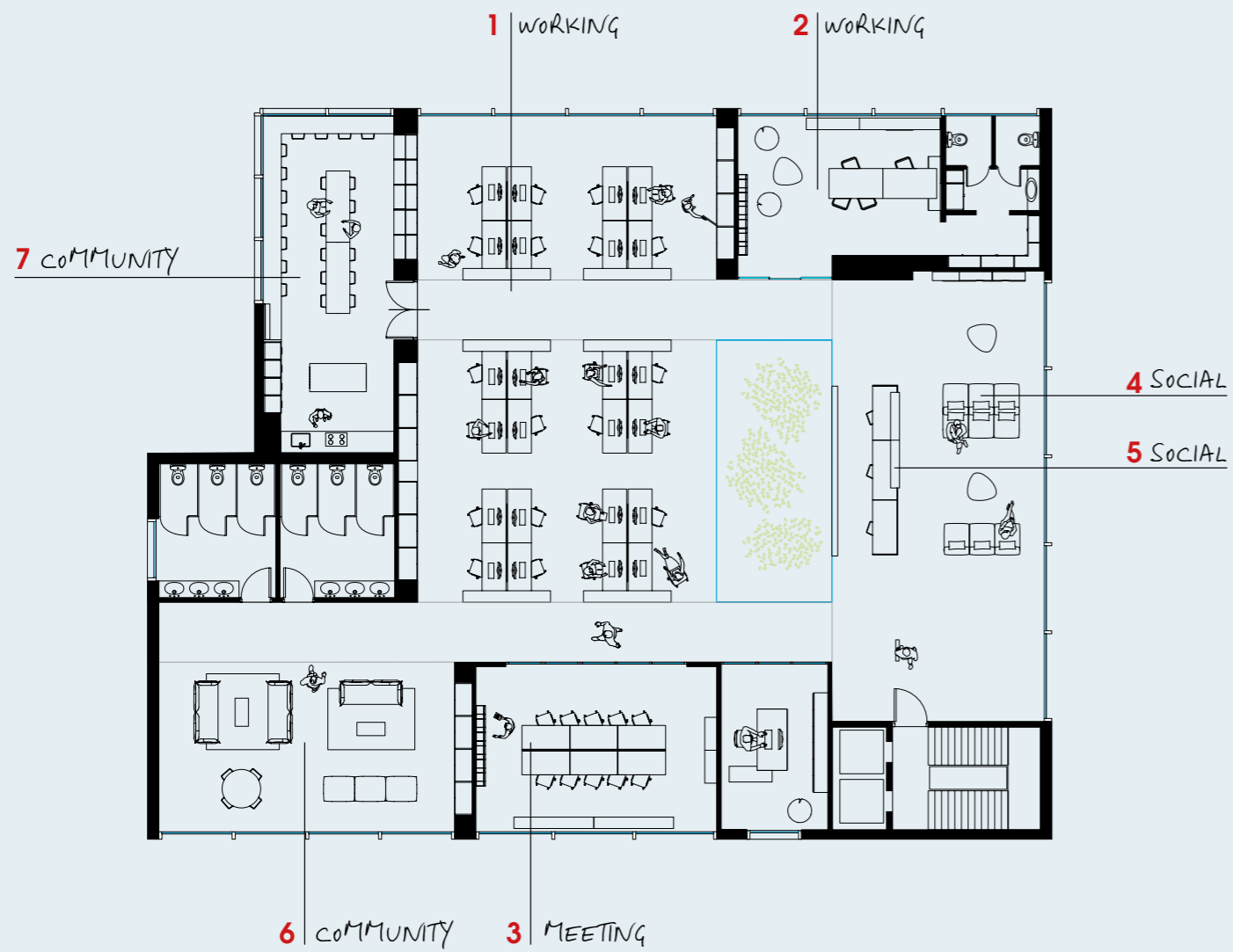

- | | | | |
|--------------|-----------------|----------------|--------------|
| WORKING | MEETING | SOCIAL | COMMUNITY |
| 1 operativo | 3 sala riunioni | 4 waiting area | 6 relaxing |
| 2 management | | 5 reception | 7 lunch time |



#totalworkdesign

PROGETTO OPEN SPACE



Z682



Z681

LA RECEPTION COMUNICA LA BRAND IDENTITY

Uno spazio in grado di comunicare al meglio i tuoi valori, dove emerge la capacità di ascoltare e trasmettere un'immagine positiva. The reception area communicates brand identity. It's a space where corporate values can be communicated successfully and an ability to listen and transmit a highly positive image emerges. La réception communique la brand identity. Un espace en mesure de communiquer au mieux vos valeurs; où émerge la capacité d'écouter et de transmettre une image vraiment positive. Der Empfang kommuniziert die Brand Identity. Ein Bereich, der Werte am besten ausdrückt und die Fähigkeit zuzuhören sowie ein positives Bild vermittelt. La recepción comunica la identidad de marca. Un espacio capaz de comunicar de la mejor manera tus valores, donde surge la capacidad de escuchar y transmitir una imagen sin duda positiva.



LA SCELTA DI MATERIALI IN ARMONIA TRA LORO È IL SEGRETO DI UN'ACCOGLIENTE AREA MANAGEMENT

La ricerca della miglior accoglienza al fine di creare spazi di relazione, ricevere ispirazioni e scambiarsi al meglio punti di vista, idee e competenze. Choosing materials that harmonise is the secret of a pleasant management area. It is a quest for the best environment aimed at creating space for relationships, inspiration and the exchange of points of view, ideas and competences. Le choix de matériaux en harmonie les uns avec les autres est le secret d'une zone management accueillante. La recherche du meilleur accueil afin de créer des espaces de communication, de recevoir des inspirations et d'échanger dans les meilleures conditions les points de vue, les idées et les compétences. Die Auswahl von harmonisch aufeinander abgestimmten Materialien ist das Geheimnis eines einladenden Managementbereichs. Besonders einladende Gestaltung, um Bereiche zu schaffen, in denen man zusammenkommt, sich inspiriert sowie Gesichtspunkte, Ideen und Kompetenzen erörtert. La elección de materiales en armonía entre sí es el secreto de un área de gerencia confortable. La búsqueda de la mejor acogida con el fin de crear espacios de relación, recibir inspiraciones e intercambiar de la mejor manera puntos de vista, ideas y conocimientos.

L'AREA OPERATIVA PROGETTATA CON SISTEMI VERSATILI STIMOLA IL PIACERE DI LAVORARE

Una grande area dove poter condividere o concentrarsi individualmente.
 Task areas planned using versatile systems stimulate the pleasure of doing a job.
 They are large areas in which to share opinions or concentrate individually.
 La zone opérationnelle projetée avec des systèmes versatiles stimule le plaisir de
 travailler. Une grande zone où l'on peut partager ou se concentrer individuellement.
 Ein mit vielseitigen Systemen geplanter Arbeitsbereich steigert
 die Freude an der Arbeit. Ein großer Bereich, der gemeinsam genutzt
 werden oder in dem man sich allein konzentrieren kann.
 El área operativa ideada con sistemas versátiles estimula el gusto de trabajar.
 Una gran área donde poder compartir o concentrarse individualmente.



SPAZI FLUIDI DOVE SVILUPPARE IL SENSO DI COMUNITÀ

Ogni progetto è unico, pensato per aumentare la sintonia interpersonale: il risultato è un luogo dove ricercare stimoli che aiutano a crescere. Spaces can flow and develop a sense of community. Each project is unique and designed to increase interpersonal relationships: the result is a place in which to seek stimulus that helps development. Des espaces fluides où développer le sens de la communauté. Chaque projet est unique, pensé pour augmenter la syntonie interpersonnelle: le résultat est un lieu où rechercher des stimulations qui aident à grandir. Fließende Räume, um den Gemeinschaftssinn zu stärken. Jedes Projekt ist einzigartig und darauf ausgelegt, die interpersonellen Beziehungen zu fördern: Resultat ist ein Ort, der Anreize zum Wachstum gibt. Espacios fluidos donde desarrollar el sentido de la comunidad. Cada proyecto es único, pensado para aumentar la sintonía interpersonal: el resultado es un lugar donde buscar estímulos que ayudan a crecer.

AREA LUNCH PER RICARICARSI, RIGENERARSI E CONVERSARE IN MODO INFORMALE

Spazi dedicati all'interscambio e all'attività ricreativa, dove poter bere un caffè o mangiare.
 A lunch area to recharge, regenerate and chat informally.
 Such space is dedicated to conversation and recreation, where you can have a cup of coffee or eat something.
 Zone lunch pour se recharger, se régénérer et converser de façon informelle. Des espaces dédiés à l'échange et aux activités récréatives, où l'on peut boire un café ou manger.
 Lunchbereich, um sich zu entspannen, zu regenerieren und informell zu unterhalten. Räume, um sich auszutauschen und zu erholen, einen Kaffee zu trinken oder etwas zu essen.
 Area lunch para reponerse, regenerarse y conversar de un modo informal. Espacios dedicados al intercambio y a la actividad recreativa, donde poder tomar un café o comer.



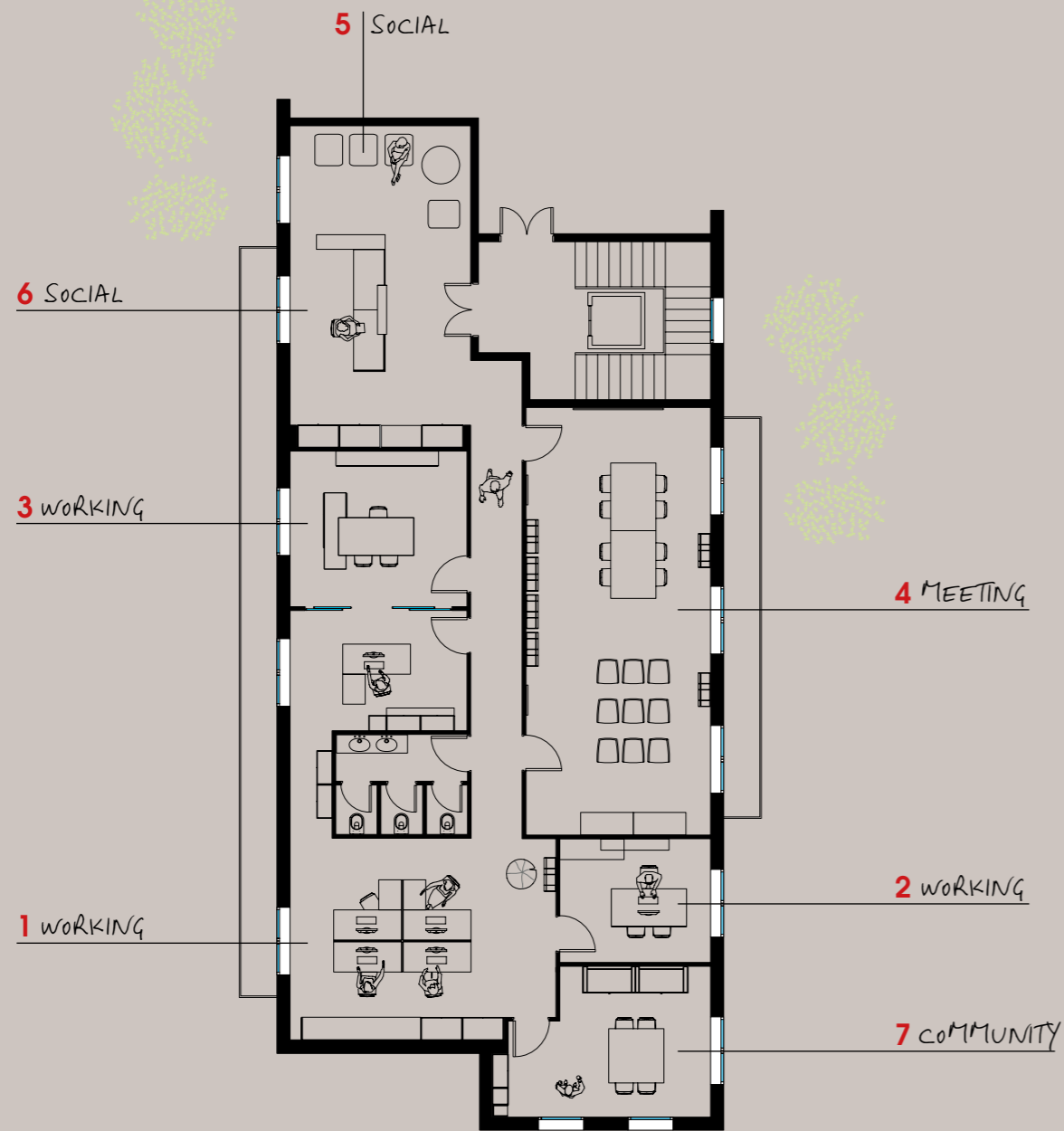

- | | | | |
|--------------|-----------------|----------------|--------------|
| WORKING | MEETING | SOCIAL | COMMUNITY |
| 1 operativo | 4 sala riunioni | 5 waiting area | 7 lunch time |
| 2 management | | 6 reception | |
| 3 business | | | |



#totalworkdesign
 PROGETTO
 UPTOWN

Z691

UN'ELEGANTE RECEPTION MIGLIORA LE RELAZIONI AZIENDALI

Forme essenziali e materiali dove le combinazioni materiche esaltano l'architettura.
 An elegant reception desk improves corporate relationships. Essential shapes and materials that combine different textures exalt the architecture.
 Une élégante réception améliore les relations d'entreprise. Des formes essentielles et des matériaux où les combinaisons matérielles exaltent l'architecture.
 Ein eleganter Empfang verbessert die unternehmerischen Beziehungen.
 Essentielle Formen und Materialien, deren Kombination die Architektur betont.
 Una recepción elegante mejora las relaciones empresariales. Formas sobrias y materiales en los cuales las combinaciones matéricas acentúan su arquitectura.





LA RICERCA DELLO SPAZIO IDEALE TRA PIÙ POSTAZIONI CREA L'INTESA PERFETTA

Soluzioni lavorative diverse si accostano tra loro creando delle relazioni capaci di comunicare sintonia, dove efficienza e creatività migliorano. A quest for the ideal space between work stations creates perfect harmony. Different solutions for different tasks come together to create an atmosphere that communicates agreement and improves efficiency and creativity. La recherche de l'espace idéal entre plusieurs postes crée l'entente parfaite. Des solutions de travail différentes s'assemblent les unes avec les autres en créant des relations en mesure de communiquer un sentiment de syntonie qui améliore l'efficacité et la créativité. Das Streben nach der idealen Gestaltung von mehreren Arbeitsplätzen schafft perfekte Harmonie. Unterschiedliche Arbeitsplätze werden zusammengefasst, wodurch Zusammenhalt entsteht sowie Leistung und Kreativität verbessert werden. La búsqueda del espacio ideal entre varios puestos de trabajo crea la colaboración perfecta. Soluciones de trabajo diferentes se combinan entre sí creando unas relaciones capaces de comunicar en sintonía, donde eficiencia y creatividad mejoran.





Z694

UN'INNOVATIVA AREA DI CONDIVISIONE GENERA E FAVORISCE BUONE STRATEGIE

Un luogo autorevole, un'ottima piattaforma di comunicazione.
 An innovative work area generates good strategies.
 An authoritative place is an excellent communications platform.
 Une zone de partage innovante génère et favorise de bonnes stratégies.
 Un lieu important, une excellente plateforme de communication.
 Ein innovativer Gemeinschaftsbereich erzeugt und fördert gute Strategien.
 Ein beeindruckender Ort, eine hervorragende Plattform zur Kommunikation.
 Un área de compartición innovadora genera y favorece buenas estrategias.
 Un lugar acreditado, una perfecta plataforma de comunicación.



UNA DINAMICA POSTAZIONE MULTIPLA CREA UN'OTTIMA CONNESSIONE

Una postazione idonea all'interazione o alla riservatezza, è suddivisa e organizzata con funzionali accessori dove tutto è a portata di mano.
 A dynamic multiple work station creates great connections.
 Work stations that facilitate interaction or privacy is sub-divided and organised with functional accessories, all readily to hand.
 Un poste multiple dynamique crée une excellente connexion. Un poste idéal pour l'interaction et la confidentialité, il est divisé et organisé avec des accessoires fonctionnels où tout est à portée de main.
 Ein dynamischer Arbeitsplatz für mehrere Personen schafft eine optimale Verbindung. Ein Arbeitsplatz für Interaktion oder mit Privatsphäre ist mit funktionalem Zubehör unterteilt oder organisiert, damit alles griffbereit ist.
 Un puesto múltiple dinámico crea una perfecta conexión. Un puesto adecuado para la interacción o la privacidad, está subdividido y organizado con accesorios funcionales donde todo está al alcance de la mano.





AUMENTANDO IL VALORE ESTETICO DEI MOMENTI DI PAUSA SI RICARICANO LE ENERGIE

Privilegiare sempre più la qualità del lavoro e l'aspetto umano, significa progettare lo spazio in modo sempre più accogliente e rigenerante. When stunning good looks are to the fore, that welcome break recharges our batteries. Privileging the quality of work and the human aspect means planning space to be more and more hospitable and regenerating. En augmentant la valeur esthétique des moments de pause, on recharge ses énergies. Privilégier de plus en plus la qualité du travail et l'aspect humain, signifie protéger l'espace de la façon la plus en plus accueillante et régénérante possible. Durch Steigerung des ästhetischen Werts der Pausenzeiten kann mehr Energie gefankt werden. Der Qualität der Arbeit und dem menschlichen Aspekt immer mehr Bedeutung beizumessen bedeutet, den Raum immer attraktiver und erholsamer zu planen. Aumentando el valor estético de los momentos de pausa se recargan las energías. Favorecer cada vez más la calidad del trabajo y el aspecto humano, significa proyectar el espacio de manera cada vez más confortable y regeneradora.



OFFICE SOLUTION ACCESSORI

Ogni postazione di lavoro può essere organizzata con molteplici accessori pensati per rendere più efficiente e funzionale il quotidiano. Every work station can be organised with a host of accessories designed to make daily work more efficient and functional. Chaque poste de travail peut être organisé avec de nombreux accessoires pensés pour rendre le quotidien plus efficace et fonctionnel. Jeder Arbeitsplatz kann mit zahlreichem Zubehör organisiert werden, das den Alltag effizienter und funktionaler gestaltet. Cada puesto de trabajo puede organizarse con múltiples accesorios pensados para volver más eficiente y funcional la vida diaria.



ARCHIVIARE CONTENERE RIPORRE

Funzionali cassettiere in metallo con chiusura
 ammortizzata per archiviare con ordine le cartelle
 sospese. Elementi classificatori interni ed esterni.
 Cassetti in metallo per riporre la cancelleria.
 Practical metal drawer sets with soft closing
 mechanism for filing hanging file folders. Internal
 and external filing elements. Metal stationery drawers.
 Des meubles à tiroirs en métal avec fermeture
 amortie pour archiver de façon ordonnée les dossiers
 suspendus. Des éléments classeurs internes et
 externes. Des tiroirs en métal pour ranger la papèterie.
 Funktionale Schubkastenelemente aus Metall
 mit Schließdämpfung, um Hängeregister
 ordentlich zu archivieren. Aktenschrankelemente
 für innen und außen. Schubkästen aus
 Metall für die Ablage von Schreibutensilien.
 Cajoneras de metal funcionales con cierre
 amortiguado para archivar las carpetas
 colgantes ordenadamente. Elementos
 clasificadores interiores y exteriores. Cajones
 de metal para guardar la papelería.





finitura bianco

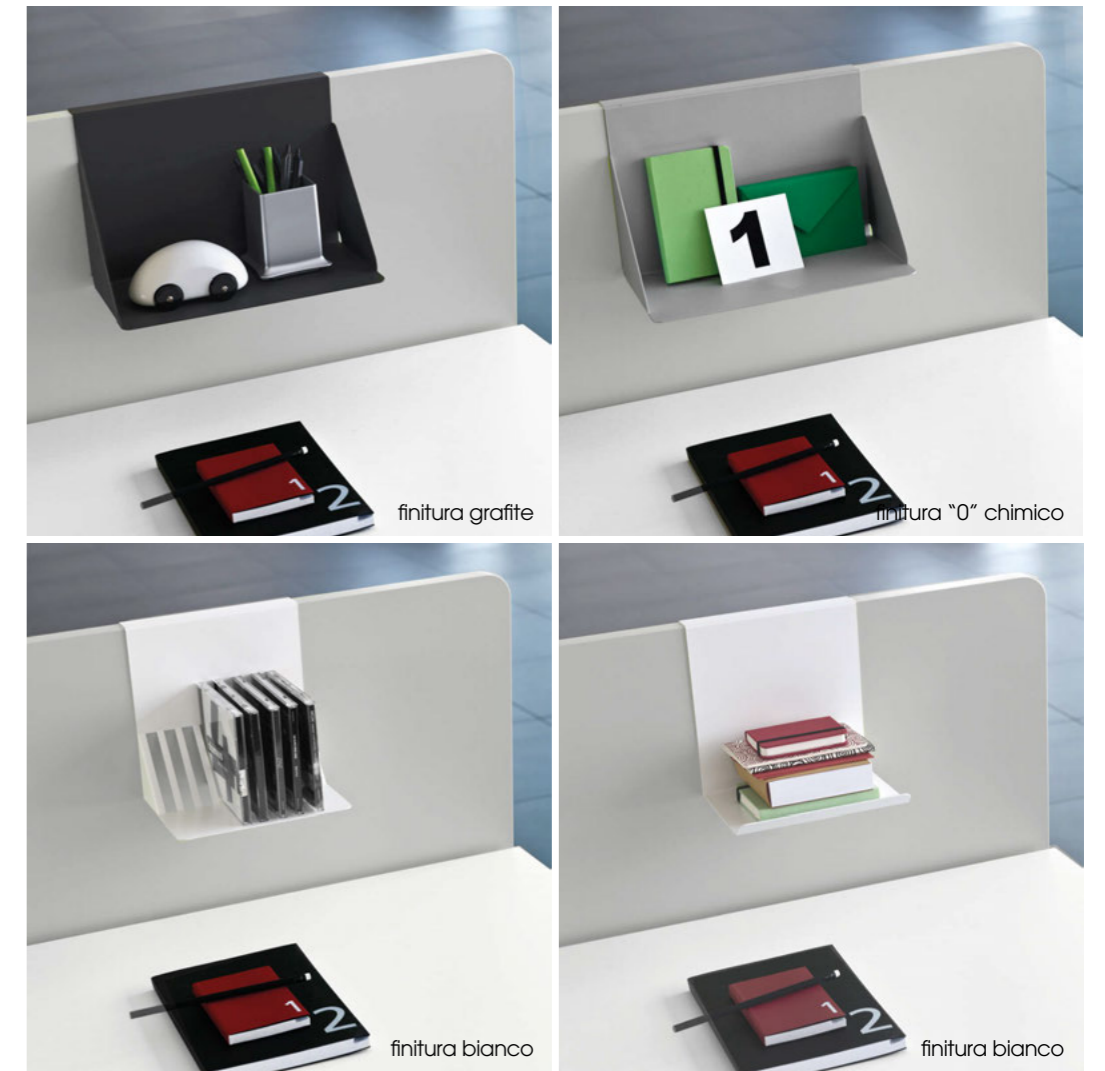

finitura grafite

finitura "0" chimico

finitura bianco

finitura bianco

ACCESSORI DA AGGANCO A SCREEN SOSPESI



Design essenziale per gli accessori in metallo bianco, "0" chimico o grafite da aggancio a screen in melaminico o in tessuto. A sinistra, scrivania dotata di gonnola in metallo finitura "0" chimico.

Essential good looks for accessories in white, anodised or graphite metal to hook onto melamine or fabricscreens. On the left, a desk with anodised metal modesty panel.

Design essentiel pour les accessoires en métal blanc, "0" chimique ou graphite à accrocher à screen en mélaminé ou en tissu. À gauche, bureau doté de voile de fond en métal finition "0" chimique.

Essentielle Design für Zubehör aus Metall in Weiß, C-Null eloxiert oder Graphit zum Einhängen am Sichtschutz aus Melamin oder aus Stoff.

Links, Schreibtisch mit Krierraum-Sichtschutz aus Metall in der Ausführung C-Null eloxiert.

Diseño sobrio para los accesorios de metal blanco, "0" químico o grafito para enganchar en los screens de melamina o de tejido.

A la izquierda, escritorio provisto de panel frontal de metal acabado "0" químico.



Vertebra Brick e modulo cablato a scomparsa



Torretta cablata da pavimento



Torretta elettrificata estraibile

SISTEMI DI CONNESSIONE E PASSACAVI



Carter in alluminio



Boccola passacavi e portapenne



Boccola passacavi

PORTA CPU

Organizzazione totale: un sistema integrato di passaggio cavi e sistemi porta CPU caratterizzato dalla linearità e dal design, ideale per le postazioni operative, per l'ambiente direzionale e i tavoli riunione.

Total organisation: an integrated system of cable glands and CPU stands featuring linear design, ideal for work stations, executive offices and meeting tables.

Organisation totale: un système intégré de passage câbles et systèmes porte CPU caractérisé par la linéarité et le design, idéal pour les postes opérationnels, l'ambiance directionnelle et les tables de réunion.

Vollständige Organisation: ein integriertes System aus Kabeldurchführungen und CPU-Haltern, das sich durch sein lineares Design auszeichnet, ideal für Arbeitsplätze, Chefbüros und Konferenztische.

Organización total: un sistema integrado de paso de cables y sistemas porta CPU caracterizado por la linealidad y el diseño, ideal para los puestos operativos, para el ambiente directivo y las mesas de reunión.



Porta CPU da aggancio a traversi

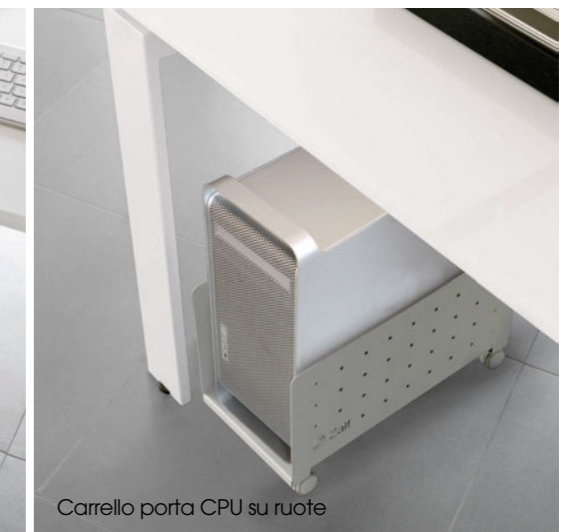

Carrello porta CPU su ruote

sedie CALLA

Sedile e schienale in rete o in pelle, base pressofusa lucida, elevazione a gas con sistema di molleggio e supporto lombare regolabile.
 Mesh or leather seat and backrest, bright cast metal base, gas lift with spring system and adjustable lumbar support.
 Siège et dossier en grillage ou en cuir, base moulée sous pression brillante, élévation à gaz avec système de suspension et support lombaire réglable.
 Sitz und Rückenlehne aus Netzmaterial oder aus Leder, Gestell aus glänzendem Druckguss, Höhenverstellung mit Gasdruckfeder und verstellbare Lendenstütze.
 Asiento y respaldo de red o de piel, base fundida a presión brillante, elevación a gas con sistema de muelles y soporte lumbar regulable.



-- 65 / 65 189/101



-- 53 / 60 193



-- 65 / 65 1105/117



-- 65 / 65 1105/117



-- 65 / 65 189/101



-- 65 / 65 194



-- 53 / 60 193



-- 48 / 60 193





sedie CRONO

Sedile e schienale imbottiti, base pressofusa in alluminio lucido o in polipropilene nero, meccanismo Synchronetek e braccioli regolabili.
Padded seat and backrest, bright cast aluminium or black polypropylene base, Synchronetek mechanism and adjustable armrests.

Siège et dossier rembourrés, base moulée sous pression en aluminium brillant ou en polypropylène noir, mécanisme Synchronetek et accoudoirs réglables.
Sitz und Rückenlehne gepolstert, Gestell aus glänzendem Aluminiumdruckguss oder aus schwarzem Polypropylen, Synchronetek-Mechanik und verstellbare Armlehnen.
Asiento y respaldo mullidos, base fundida a presión de aluminio brillante o de polipropileno negro, mecanismo Synchronetek y brazos regulables.



... 76 / 76 1116



... 76 / 76 198



... 76 / 76 198



sedie FLEXA

Sedile imbottito in poliuretano espanso, schienale in co-polimero flessibile ad alta densità, base girevole in polipropilene rinforzato in fibra di vetro. Supporto lombare regolabile.
 Polyurethane foam padded seat, high density co-polymer foam backrest, fibreglass reinforced polypropylene revolving base. Adjustable lumbar support.
 Siège rembourré en polyuréthane expansé, dossier en copolymère flexible à haute densité, base tournante en polypropylène renforcé en fibre de verre. Support lombaire réglable.
 Gepolsterter Sitz aus Polyurethanschaum, Rückenlehne aus flexiblem, hoch verdichtetem Copolymer, Drehgestell aus glasfaserverstärktem Polypropylen. Verstellbare Lendenstütze.
 Asiento mullido de espuma de poliuretano, respaldo de copolimero flexible de alta densidad, base giratoria de polipropileno reforzado en fibra de cristal. Soporte lumbar regulable.



... 65 / 67 1106/118



... 54 / 60 188





sedie ECO

Sedile imbottito e schienale in tessuto Spider, base pressofusa in alluminio lucido, meccanismo Syncro bileva multiblock e braccioli regolabili.
 Padded seat and Spider fabric backrest, bright cast aluminium base, Syncro twin lever multiblock mechanism and adjustable armrests.
 Siège rembourré et dossier en tissu Spider, base moulée sous pression en aluminium brillant, mécanisme Syncro bi-levier multiblock et accoudoirs réglables.
 Gepolsterter Sitz und Rückenlehne aus Stoff Spider, Gestell aus glänzendem Aluminiumdruckguss, Synchron-Multiblock-Mechanik mit zwei Hebeln und verstellbare Armlehnen.
 Asiento mullido y respaldo de tejido Spider, base fundida a presión de aluminio brillante, mecanismo Syncro de doble palanca multiblock y brazos regulables.



-- 74 / 74 | 115/131



-- 74 / 74 | 192/104



-- 74 / 74 | 115/131



-- 74 / 74 | 192/104



-- 54 / 60 | 190

sedie OTAVO

Sedile imbottito e schienale in rete Vega o imbottito, base in polipropilene nero, meccanismo minisincro e supporto lombare regolabile.
 Padded seat and Vega mesh or padded backrest, black polypropylene base, minisynchro mechanism and adjustable lumbar support.
 Siège rembourré et dossier en grillage Vega ou rembourré, base en polypropylène noir, mécanisme minisynchro et support lombaire réglable.
 Gepolsterter Sitz und Rückenlehne aus Netzmaterial Vega oder gepolstert, Gestell aus schwarzem Polypropylen, Minisynchron-Mechanik und verstellbare Lendenstütze.
 Asiento mullido y respaldo de red Vega o mullido, base de polipropileno negro, mecanismo minisincro y soporte lumbar regulable.



-- 66 / 66 190/102

-- 66 / 66 190/102

-- 66 / 66 190/102



-- 66 / 66 195/107

-- 66 / 66 195/107

sedie POCKET

Struttura in metallo verniciato, scocca in polipropilene, impilabile nella versione senza tavoletta scrittoio ribaltabile.
 Painted metal frame, polypropylene shell, the version without fold-away writing tablet is stackable.
 Structure en métal verni, coque en polypropylène, empilable dans la version sans tablette bureau rabattable.
 Gestell aus lackiertem Metall, Sitzschale aus Polypropylen, stapelbar in der Version ohne klappbare Schreibplatte.
 Estructura de metal pintado, armazón de polipropileno, apilable en la versión sin tablero de escritorio volcable.



-- 42 / 41 182

-- 42 / 41 182



OFFICE SOLUTION IDENTITY CARD

Finiture e materiali ecosostenibili, una straordinaria ricerca di colori e di materiali dalle piacevoli qualità percettive e tattili, dalla facile pulizia e dalle eccezionali doti di resistenza.

Eco-sustainable finishes and materials: a range of colours and materials with pleasant appearance and feel, easily cleaned and exceptionally robust.

Finitions et matériaux écosoutenables, une recherche de couleurs et de matériaux aux qualités perceptives et tactiles agréables, facile à nettoyer et avec des qualités exceptionnelles de résistance.

Umweltverträgliche Ausführungen und Materialien, gezielt ausgewählte Farben und Materialien mit angenehmen optischen und taktilen Eigenschaften, die leicht zu reinigen und hoch widerstandsfähig sind.

Acabados y materiales ecosostenibles, una búsqueda de colores y materiales de agradables cualidades perceptivas y táctiles, de fácil limpieza y de excelentes características de resistencia.

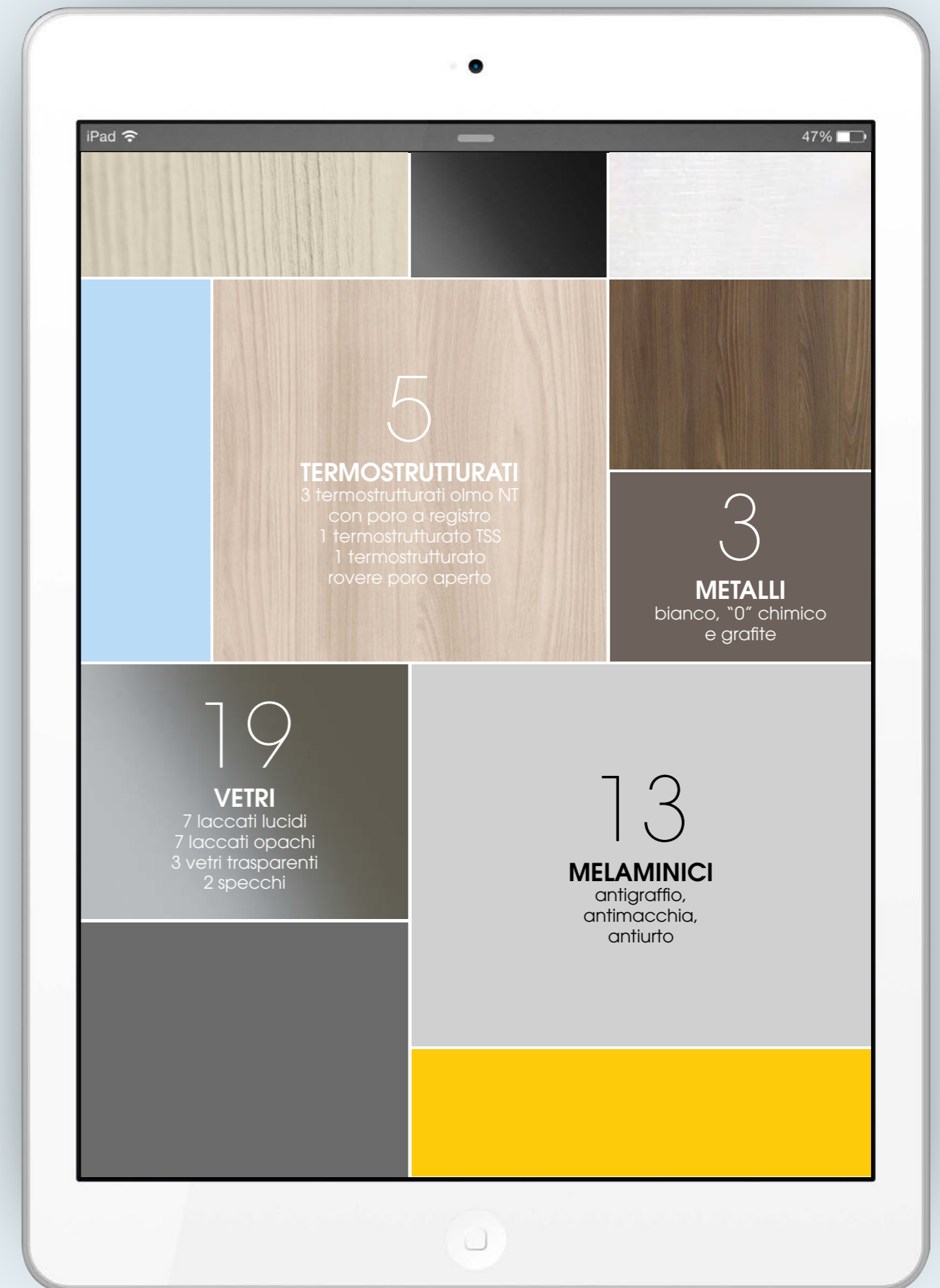



gamba a portale
P01

Gamba a portale P01 in metallo verniciato bianco, "0" chimico, grafite sez. 10x2 cm.
 P01 portal leg in white painted, anodised or graphite metal, section 10x2cm.
 Pied à portique P01 en métal verni blanc, "0" chimique, graphite sect. 10x2 cm.
 Kufengestell P01 aus lackiertem Metall in Weiß, C-Null eloxiert, Graphit, Querschnitt 10x2 cm.
 Pata en forma de portal P01 de metal pintado blanco, "0" químico, grafito, de 10x2 cm de secc.

SCRIVANIE DESKS

Scrivania piano in melaminico
Melamine top desk

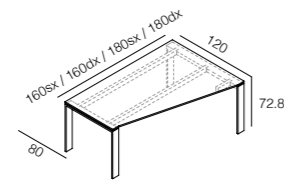
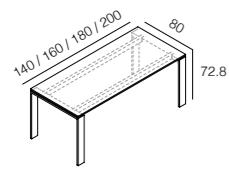

Scrivania piano in vetro
Glass top desk

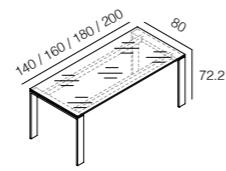

PIANI DI SERVIZIO SERVICE DESKS

Piani di servizio in melaminico
Melamine service desks

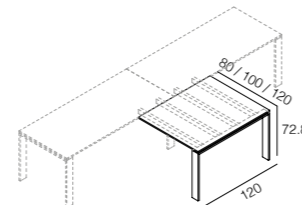
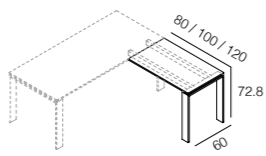
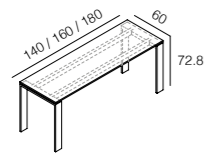

Piani di servizio in vetro
Glass service desks

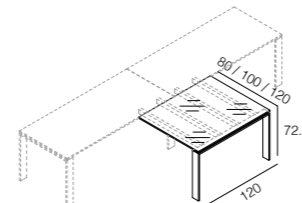
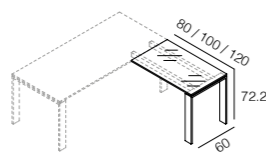
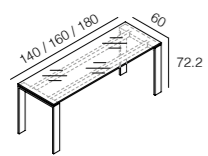

TAVOLI TABLES

Tavoli direzionali piano in melaminico
Melamine top managerial tables

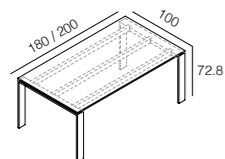

Tavoli direzionali piano in vetro
Glass top managerial tables

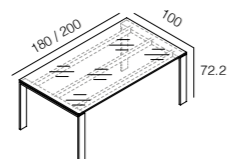

Tavoli riunione piano in melaminico
Melamine top meeting tables

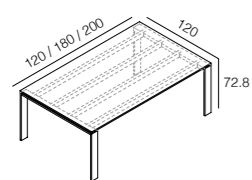

Tavoli riunione piano in vetro
Glass top meeting tables

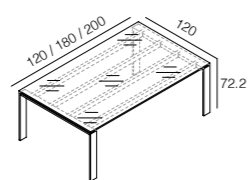

Tavolo rotondo piano in melaminico
Melamine top round table

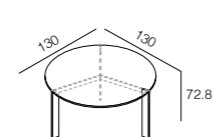

Tavolo rotondo piano in vetro
Glass top round table

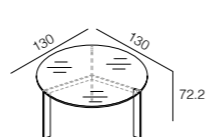

gamba a telaio
P02

Gamba a telaio P02 in metallo verniciato bianco, grafite, sez. 5x1,5 cm.
 P02 frame leg in white painted or graphite metal, section 5x1.5cm.
 Pied structure P02 en métal verni blanc, graphite, sect. 5x1,5 cm.
 4-Fuß-Gestell P02 aus lackiertem Metall in Weiß, Graphit, Querschnitt 5x1,5 cm.
 Pata enmarcada P02 de metal pintado blanco, grafito, de 5x1,5 cm de secc.

SCRIVANIE DESKS

Scrivania piano in melaminico
Melamine top desk

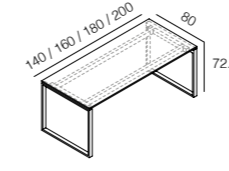

Scrivania piano in vetro
Glass top desk

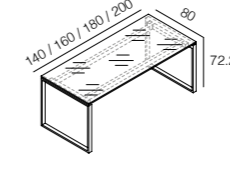

PIANI DI SERVIZIO SERVICE DESKS

Piani di servizio in melaminico
Melamine service desks

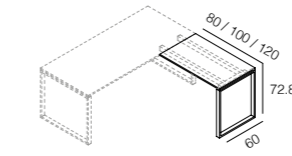
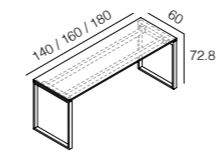

Piani di servizio in vetro
Glass service desks

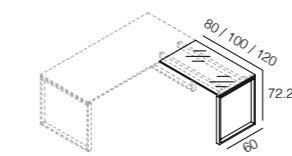
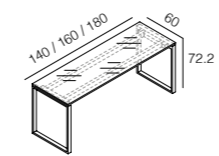

TAVOLI TABLES

Tavoli direzionali piano in melaminico
Melamine top managerial tables

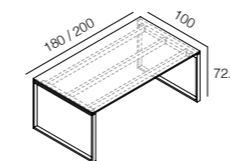

Tavoli direzionali piano in vetro
Glass top managerial tables

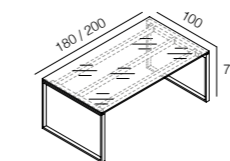



gamba piena
P03

Gamba piena P03 struttura interna in metallo verniciato bianco, grafite, rivestimento esterno in melaminico nei colori struttura.
 P03 full leg with internal structure in white painted or graphite metal, external melamine facing in structure colours.
 Pied plein P03 structure interne en métal verni blanc, graphite, revêtement externe en mélaminé dans les couleurs de la structure.
 Wangengestell P03 Innenstruktur aus lackiertem Metall in Weiß, Graphit, Außenverkleidung aus Melamin in den Korpusfarben.
 Pata llena P03 con estructura interior de metal pintado blanco, grafito, revestimiento exterior de melamina en los colores de la estructura.

SCRIVANIE DESKS

Scrivania piano in melaminico
Melamine top desk

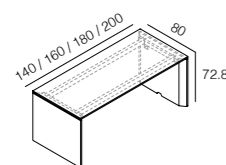

PIANI DI SERVIZIO SERVICE DESKS

Piani di servizio in melaminico
Melamine service desks



TAVOLI TABLES

Tavoli direzionali piano in melaminico
Melamine top managerial tables

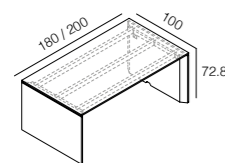

gamba con contenimento
P04

Gamba terminale P04 con contenimento in melaminico nei colori struttura.
 P04 end leg with melamine storage unit in structure colours.
 Pied terminal P04 avec rangement en mélaminé dans les couleurs de la structure.
 Seitengestell P04 mit Staufächern aus Melamin in den Korpusfarben.
 Pata terminal P04 con elemento contenedor de melamina en los colores de la estructura.

Gamba terminale con contenimento
End leg with storage unit

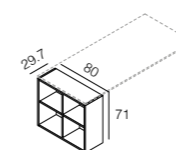

per scrivania L. 160 ordinare traversi L. 140
 per scrivania L. 180 ordinare traversi L. 160
 per scrivania L. 200 ordinare traversi L. 180
 for desk w. 160 order frames w. 140
 for desk w. 180 order frames w. 160
 for desk w. 200 order frames w. 180

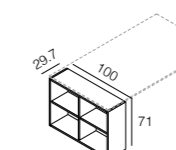

per scrivania L. 180 ordinare traversi L. 160
 per scrivania L. 200 ordinare traversi L. 180
 for desk w. 180 order frames w. 160
 for desk w. 200 order frames w. 180



gamba con cassetti
P05

Gamba terminale P05 con cassetti in melaminico nei colori struttura.
 P05 end leg with melamine drawer set in structure colours.
 Pied terminal P05 avec tiroirs en mélaminé dans les couleurs de la structure.
 Seitengestell P05 mit Schubfächern aus Melamin in den Korpusfarben.
 Pata terminal P05 con cajones de melamina en los colores de la estructura.

Gamba terminale con cassetti
End leg with drawers

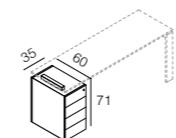

per scrivania L. 160 ordinare traversi L. 140
 per scrivania L. 180 ordinare traversi L. 160
 for desk w. 160 order frames w. 140
 for desk w. 180 order frames w. 160

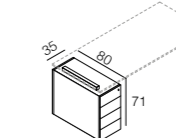

per scrivania L. 160 ordinare traversi L. 140
 per scrivania L. 180 ordinare traversi L. 160
 per scrivania L. 200 ordinare traversi L. 180
 for desk w. 160 order frames w. 140
 for desk w. 180 order frames w. 160
 for desk w. 200 order frames w. 180



CASSETTIERE

Cassettiere in melaminico in 19 finiture e cassettiere in metallo verniciato bianco, "0" chimico, grafite.
 Melamine drawer sets in a choice of 19 finishes and white painted, anodised or graphite metal drawer sets.
 Meubles à tiroirs en mélaminé dans 19 finitions et meubles à tiroirs en métal verni blanc, "0" chimique, graphite.
 Schubkastenelemente aus Melamin in 19 Ausführungen und Schubkastenelemente aus lackiertem Metall in Weiß, C-Null eloxiert, Graphit.
 Cajoneras de melamina en 19 acabados y cajoneras de metal pintado blanco, "0" químico, grafito.

Cassettiere in melaminico
Melamine drawers

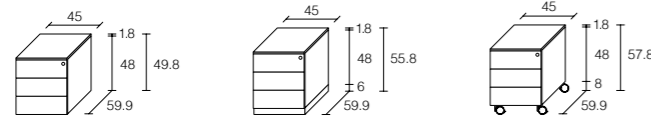

Cassettiere in metallo
Metal drawers

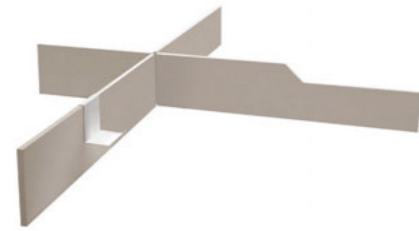
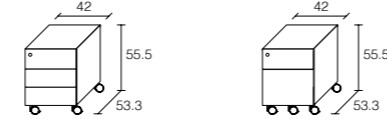

SCREEN

Screen sospesi in melaminico, tessuto o vetro. Screen a pavimento in melaminico.
 Suspended melamine, fabric or glass screens. Floor-standing melamine screen.
 Screen suspendus en mélaminé, tissu ou verre. Screen au sol en mélaminé.
 Hängender Sichtschutz aus Melamin, Stoff oder Glas. Stehender Sichtschutz aus Melamin.
 Screens colgantes de melamina, tejido o cristal. Screens de suelo de melamina.

Screen sospesi in melaminico
Melamine not floor-level screens

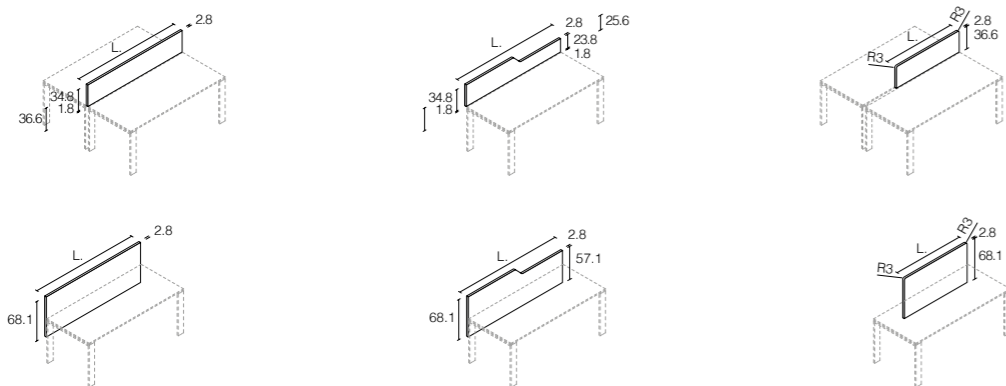

Screen laterale in melaminico per scrivanie dotate di screen lato lungo
 Melamine side screen for desk with screen on the longer side

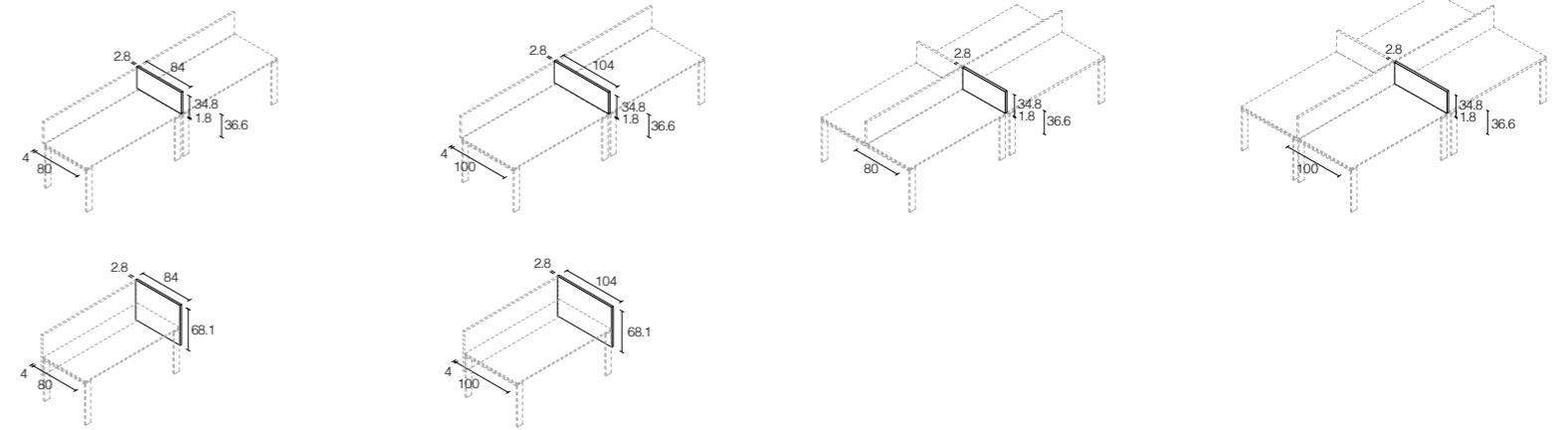

Screen laterale in melaminico per scrivanie dotate di dattilo e screen lato lungo
 Melamine side screen for desk with type-desk and screen on the longer side

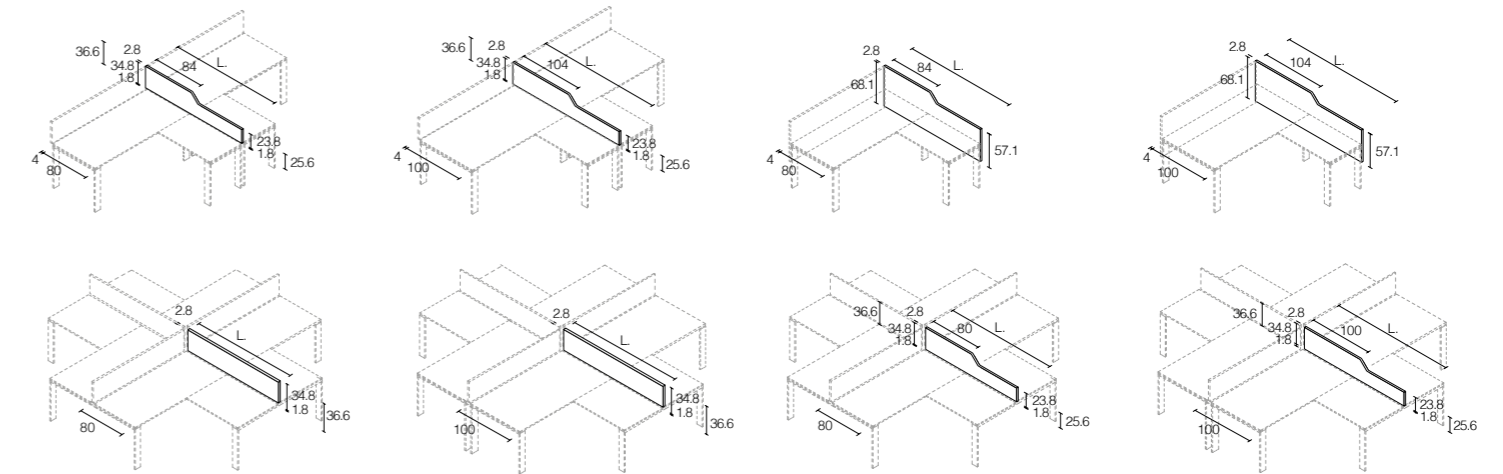

Screen sospesi in tessuto
Fabric not floor-level screens



Screen sospesi in vetro
Glass not floor-level screens

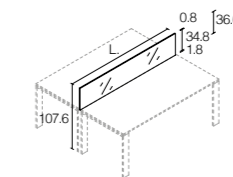

Screen a pavimento in melaminico
Melamine floor-level screens

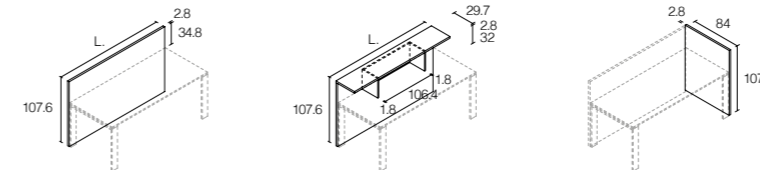

Screen a pavimento in melaminico per reception
 Melamine floor-level screens for reception

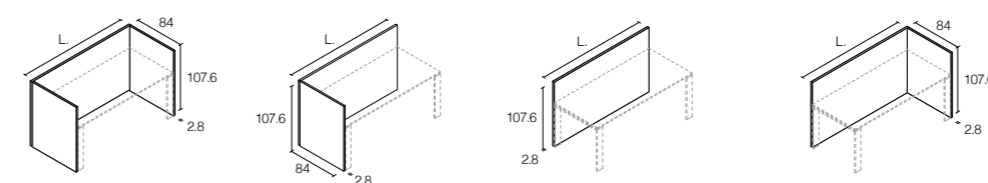

Mensola d'aggancio per screen reception
 Docking shelf for screen reception

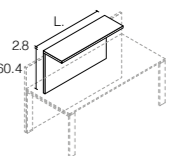

OFFICE SOLUTION

MATERIALI E COLORI

Per i colori, i materiali e gli aspetti tecnici, fare riferimento ai listini prezzi e relativi aggiornamenti.

For colours, materials and technical features, please refer to the latest price lists.

Pour les couleurs, les matériaux et les aspects techniques, se référer aux listes de prix et mises à jour correspondantes.

Für Farben, Materialien und technische Aspekte wird auf die Preislisten mit entsprechenden Aktualisierungen verwiesen.

Para los colores, los materiales y los aspectos técnicos, referirse a las listas de precios y a las actualizaciones relativas.



TERMOSTRUTTURATO OLMO NT CON PORO A REGISTRO
THERMOSTRUCTURED ELM NT WITH REGISTER PORE



TERMOSTRUTTURATO ROVERE PORO APERTO
THERMOSTRUCTURED OAK WITH OPEN PORE



TERMOSTRUTTURATO TSS
THERMOSTRUCTURED TSS

5 termostrutturati
thermostructured

Euromobil
cucine

Finiture Zalf coordinate con Euromobil.
Zalf finishings coordinated with Euromobil.
Finitions Zalf coordonnées avec Euromobil.
Ausführungen von Zalf passend zu Euromobil.
Acabados Zalf combinados con Euromobil.

3 metalli metals



19 vetri glasses



13 melaminici melamines

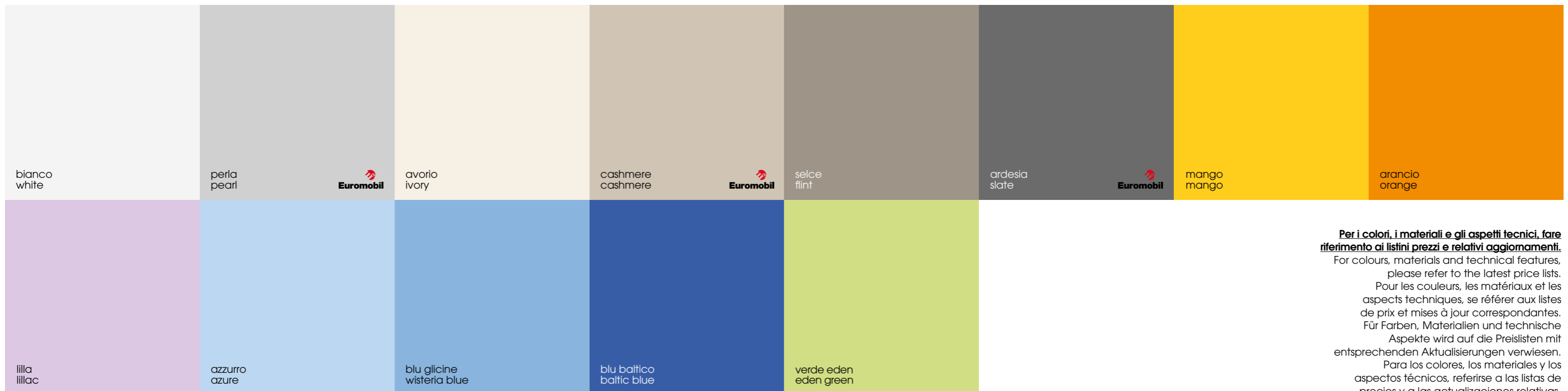

Finiture Zalf coordinate con Euromobil.
Zalf finishings coordinated with Euromobil.
Finitions Zalf coordonnées avec Euromobil.
Ausführungen von Zalf passend zu Euromobil.
Acabados Zalf combinados con Euromobil.

Per i colori, i materiali e gli aspetti tecnici, fare riferimento ai listini prezzi e relativi aggiornamenti.
For colours, materials and technical features, please refer to the latest price lists.
Pour les couleurs, les matériaux et les aspects techniques, se référer aux listes de prix et mises à jour correspondantes.
Für Farben, Materialien und technische Aspekte wird auf die Preislisten mit entsprechenden Aktualisierungen verwiesen.
Para los colores, los materiales y los aspectos técnicos, referirse a las listas de precios y a las actualizaciones relativas.



Scopri i contenuti extra
con l'app Gruppo Euromobil
Check out the extra content
with Gruppo Euromobil app

Villaggio Expo di Cascina Merlata Expo Milano 2015



OFFICIAL FURNITURE PARTNER EXPO VILLAGE CASCINA MERLATA FOR EXPO MILANO 2015

Importante riconoscimento per Euromobil all'Expo 2015 di Milano. È stata selezionata, come azienda espressione del Made in Italy, per fornire tutti gli arredi degli spazi domestici del Villaggio Expo di Cascina Merlata. Si tratta di una realizzazione importante, composta da edifici a torre, sviluppata e progettata da diversi studi di architettura, CZA Architetti, C+S Associati, Mario Cucinella, Pura, b22, Teknoarch, e messa a punto secondo i più avanzati principi di sostenibilità.

FORNITORE ARREDI PER IL NUOVO CAMPUS UNIVERSITARIO BOCCONI DI MILANO

L'università Commerciale Luigi Bocconi di Milano, il più prestigioso Ateneo italiano, ha scelto Gruppo Euromobil per arredare il nuovo edificio di viale Bligny 22 adibito a residenza per studenti. L'ampio progetto, realizzato dallo studio di architettura Fabio Noni di Milano, prevede arredi su misura per sessantadue appartamenti con centosettantasei posti letto e ventotto cucine. Per gli spazi collettivi Gruppo Euromobil ha fornito le quattro cucine, l'area accoglienza, la zona reception, il guardaroba e tutti gli spazi comuni.

Gruppo Euromobil CONTRACT

UN UNICO REFERENTE: DAL PROGETTO ALLA REALIZZAZIONE CUSTOM-MADE

Le forniture internazionali rappresentano per il Gruppo Euromobil uno scenario progettuale importante. Infatti, grazie a sistemi e collezioni integrabili e all'adattamento su misura del prodotto, l'Azienda può misurarsi con progetti differenti da quelli richiesti dal mercato dell'arredamento contemporaneo di serie. Design, flessibilità e funzionalità consentono così ad Euromobil Cucine, Zalf Mobili e Désirée divani di produrre esclusivamente in Italia, nelle tre sedi in Veneto, mobili pronti a realizzare progetti eterogenei per la committenza internazionale.



Università Bocconi Milano 2016



DIVANI E POLTRONE

sofas and armchairs canapés et fauteuils sofas und sessel sofás y butacas



Britt design R&S Désirée: divano sofa canapé sofa sofá

SCOPRI LA PROPOSTA
COMPLETA DELLA
COLLEZIONE DIVANI,
POLTRONE E COMPLEMENTI
CONSULTANDO IL SITO
GRUPPOEUROMOBIL.COM

See our full collection of sofas, armchairs and complementary items on our website gruppoeuromobil.com
Découvrez la proposition complète de la collection canapés, fauteuils et compléments en consultant le site gruppoeuromobil.com
Entdecken Sie unser komplettes Angebot der Kollektion Sofas, Sessel und Ergänzungselemente auf der Internetseite gruppoeuromobil.com
Descubre la propuesta completa de la colección de sofás, butacas y complementos consultando el sitio gruppoeuromobil.com



Koster design Marc Sadler: poltrona armchair fauteuil sessel butaca
Sabi design Setsu & Shinobu Ito: tavolino coffee table table basse beistelltisch mesita



FiloAntiss33 design R&S Euromobil e Roberto Gobbo

Euromobil
 cucine

CUCINE
 kitchens cuisines küchen cocinas

**PUOI TROVARE
 SOLUZIONI ALTERNATIVE
 DI CUCINA, LIVING
 E COMPLEMENTI SUL SITO
 GRUPPOEUROMOBIL.COM**

You can find alternative solutions for your kitchen and living room as well as a host of complementary items on our website gruppoeuromobil.com
 Vous pouvez trouver des solutions alternatives de cuisine, living et compléments sur le site gruppoeuromobil.com
 Sie finden alternative Lösungen für Küche, Wohnraum und Ergänzungselemente auf der Internetseite gruppoeuromobil.com
 Puedes encontrar soluciones alternativas de cocina, living y complementos en el sitio gruppoeuromobil.com



FiloLain33 design R&S Euromobil e Roberto Gobbo



Cabinet Kitchen design R&S Euromobil



KNOW-HOW TECNOLOGICO E PROGETTUALE D'ECCELLENZA

QUALITÀ E SICUREZZA TOTALE

Ante dotate di cerniere con sistema decelerante integrato con regolazione in altezza, larghezza e profondità. Cassetti con guide a scomparsa con sistema decelerante integrato (estrazione parziale e totale) che ammortizza la chiusura.

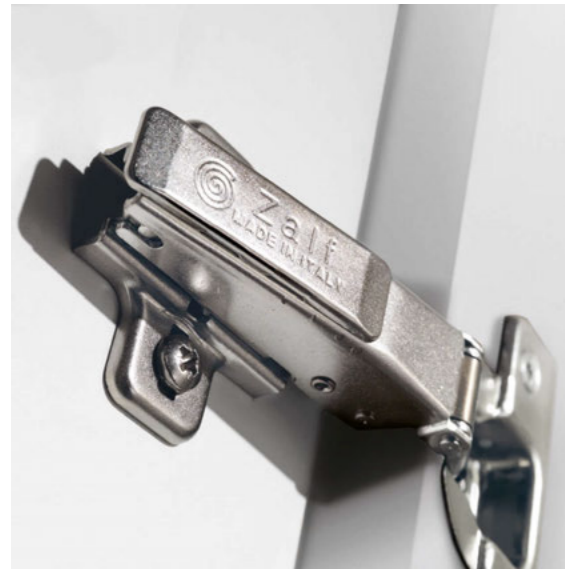

STANDARD PRODUTTIVI D'ECCELLENZA

Tutti i prodotti Zalf vengono progettati e costruiti secondo rigidi criteri di sicurezza e rispettando le normative ergonomiche, nella logica del rispetto del consumatore finale. Per verificare la qualità dei propri prodotti, Zalf invia periodicamente una selezione di mobili (prevista dalle normative vigenti), all'Istituto Italiano maggiormente accreditato a certificare il rispetto della normativa europea Uni En 14749.



ECOSOSTENIBILITÀ E RISPETTO DELLA NATURA

Nel massimo rispetto dell'ambiente e della natura, tutti gli ecopannelli sono fatti in particelle di legno ricavate dal riutilizzo di materiale legnoso. Questi ecopannelli sono conformi al regolamento "CARB Fase 2" che abbassa drasticamente, rispetto agli standard attuali, i limiti massimi consentiti di emissione di formaldeide. Inoltre, per ridurre al minimo le emissioni e tutelare l'ambiente, tutti i nostri imballi (polistirolo, cartone e termoretraibile) sono riciclabili al 100%.

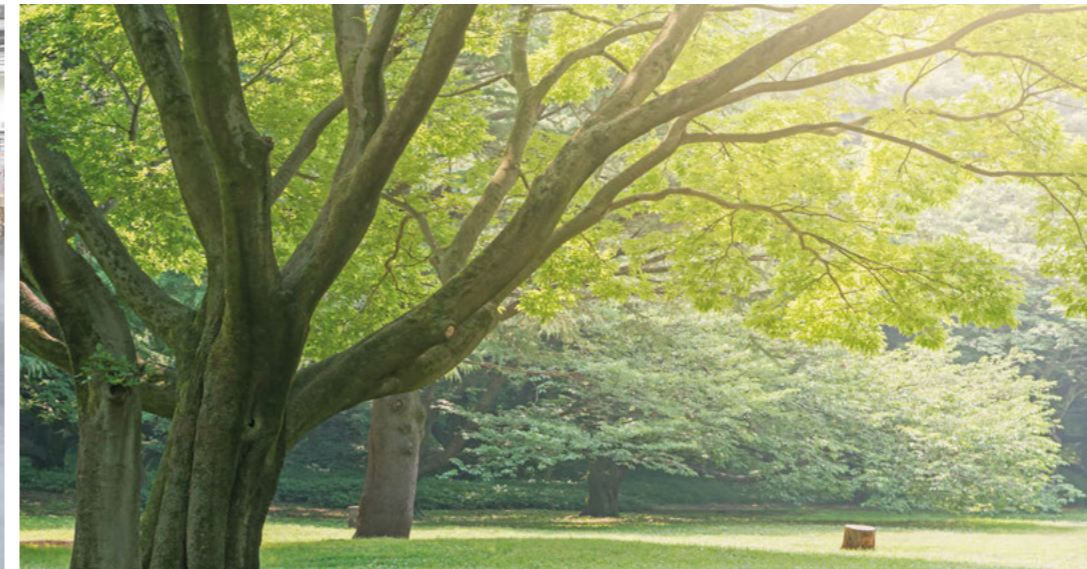

TUTELA DELLA SALUTE:
TUTTI I MOBILI
SONO REALIZZATI
CON PANNELLI
DI PARTICELLE DI LEGNO
(CARB FASE 2)
CON BASSISSIME
EMISSIONI DI FORMALDEIDE
(-35% RISPETTO
ALLA NORMATIVA
VIGENTE CLASSE E1)

MATERIALI DI QUALITÀ: IL MELAMINICO UNA SCELTA CHE SUPERA IL TEMPO

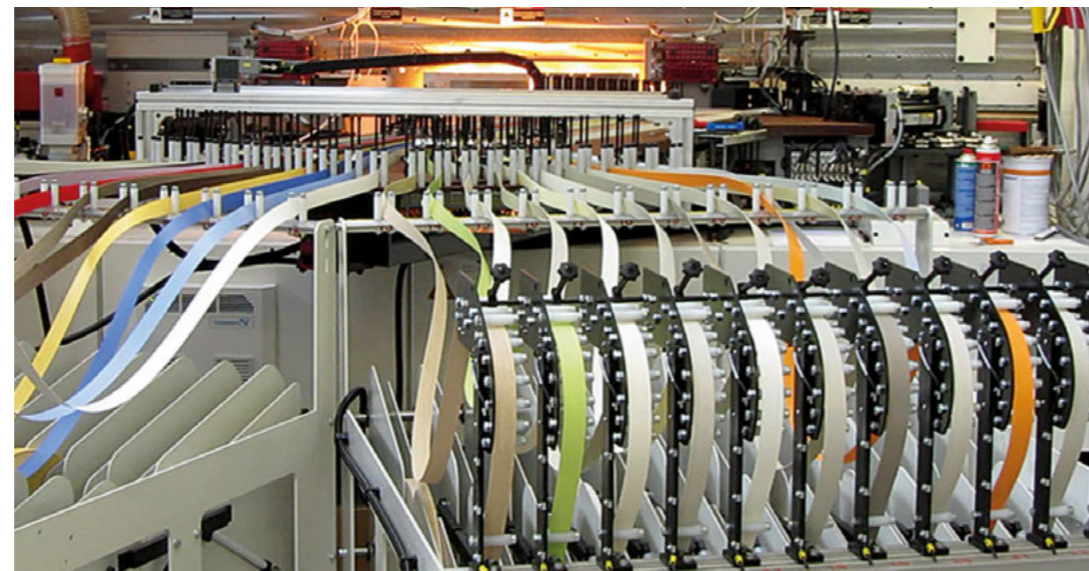

COLLANTI POLIURETANICI INNOVATIVI

Collanti poliuretani con ottime proprietà adesive che permettono incollaggi estremamente resistenti alle temperature, all'acqua e ai solventi. L'utilizzo di nuovi materiali e tecnologie garantiscono maggiori performance di prodotto. Tutto questo grazie ad un processo produttivo totale, dal semilavorato al prodotto finito. L'alta qualità dei prodotti è garantita dalla lavorazione eseguita a regola d'arte.

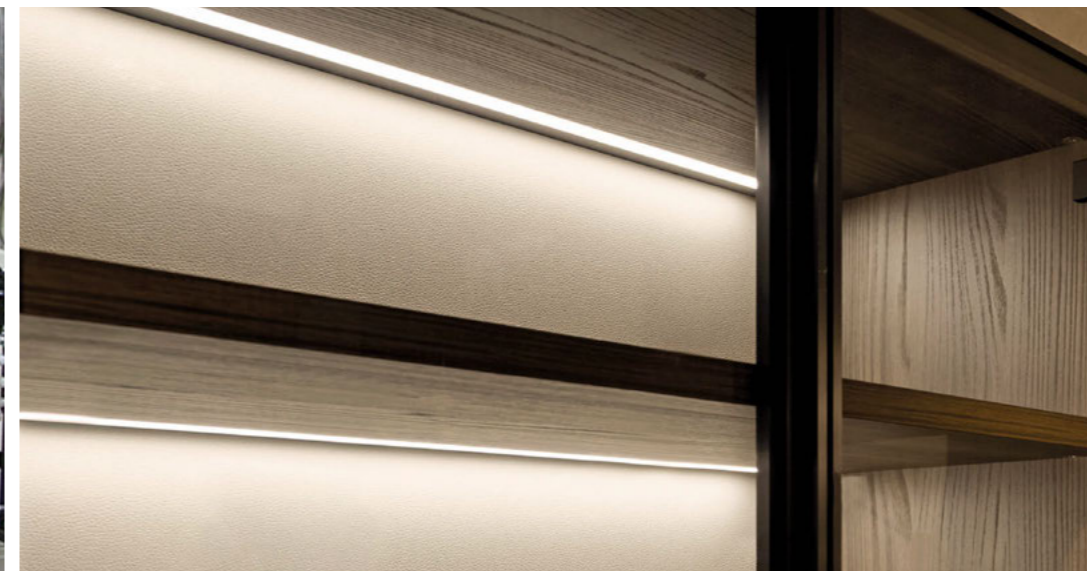

ILLUMINAZIONE A RISPARMIO ENERGETICO

Zalf è molto attenta alle economie domestiche, propone e suggerisce una varia gamma di sistemi illuminotecnici con fonte luminosa a LED, rispetto alle lampade a fluorescenza hanno un risparmio energetico fino all'80% superiore, una durata di vita lunga, dimensioni ridotte, non producono raggi ultravioletti e generano pochissimo calore, non fanno uso di mercurio e piombo e pertanto ne consente lo smaltimento indifferenziato.



PROGRAMMA GRAFICO ADA: TECNOLOGIA PROGETTILE

IL GRANDE
UNIVERSO ZALF
OFFICE SOLUTION
LIVING SOLUTION
NIGHT SOLUTION
YOUNG SOLUTION

Scegliere Zalf significa disporre di una vasta collezione di prodotti, integrati e trasversali nelle finiture e nei materiali, che possono essere combinati insieme in un numero infinito di soluzioni differenti: il risultato è un effetto "moltiplicatore" di possibilità compositive, unico nel settore dell'arredo. I sistemi Zalf, quindi, non propongono una sola soluzione preconfezionata, bensì forniscono gli strumenti e le soluzioni per costruire il proprio ambiente.

design R&S Zalf e Roberto Gobbo



Philippe Daverio:
Gruppo Euromobil e l'Arte.
Philippe Daverio:
Gruppo Euromobil and Art.

Gruppo Euromobil main sponsor
Piero Guccione "L'Azzurro" Castello,
Brescia, dal 2 ottobre 2005 al 20 gennaio 2006



Milano Triennale, ICS Meet Design 2013



Sport
Design
Arte.

Gruppo
Euromobil

GRUPPO EUROMOBIL UN'IMPRESA DI DESIGN TRA ARTE E SPORT

I NOSTRI TRAGUARDI:
DAL 1972 OLTRE 40 ANNI DI DESIGN E
DAL 1982 OLTRE 30 ANNI DI ARTE, CULTURA E SPORT

Il Gruppo Euromobil e i fratelli Lucchetta hanno creato una relazione nuova ed originale tra industria e arte-design-sport, realizzando una specifica unicità. Una corporate identity unica e distintiva, conseguita attraverso il sostegno di oltre quattrocento mostre d'arte nel mondo, la partecipazione a prestigiosi eventi di design e il successo in diverse discipline e manifestazioni sportive. Il marchio del Gruppo Euromobil è stato abbinato ad iniziative culturali di grandissima qualità e risonanza, ne sono conferme le esposizioni parigine "Leonardo da Vinci. Disegni e Manoscritti" e "Il dagherrotipo francese. Un oggetto fotografico", realizzate rispettivamente al Louvre e al Museo d'Orsay.

UN BRAND PROTAGONISTA NEL MONDO

GRUPPO EUROMOBIL: UNA CORPORATE IDENTITY
DISTINTIVA CON OLTRE 40 ANNI DI SAPERE
TECNOLOGICO E CULTURA ARTIGIANALE

Un'impresa che opera in qualità rispettando l'ambiente e che, con Total Home Design, arreda tutte le aree della casa. Standard produttivi selettivi e capacità di esportazione importante attraverso più di 800 punti vendita distribuiti nel mondo. Una cultura della ricerca come storia creativa di opportunità di crescita per il futuro grazie a progetti originali, prodotti affidabili, curati nel dettaglio, materiali ecosostenibili e un servizio di alto livello: valori indispensabili per vivere da protagonisti.



GRUPPO
EUROMOBIL,
PRESENTA LA 8ª
EDIZIONE DEL
PREMIO
UNDER
30

Gruppo
Euromobil

ARTEFIERA Bologna
Gruppo Euromobil dal 2007
è main sponsor di ArteFiera
e istituisce il premio
"GRUPPO EUROMOBIL UNDER 30"



Main sponsor di "Leonardo Da Vinci. Disegni e manoscritti."
Museo del Louvre, Parigi.
Dal 13 maggio al 17 agosto 2003.



Gianni Moscon Campione d'Italia Under 23 anno 2015
Oltre 30 anni di attività del team
8 titoli mondiali conquistati, 2 titoli europei, 27 titoli nazionali

Gruppo Euromobil main sponsor
"Alberto Burri Unico e Multiplo"
Gaeta, dal 14 giugno al 12 ottobre 2014

Concept and Graphic Design:
valentinicesarotti associati

Images:
studioEIKE

Photo:
Ezio Prandini

Styling:
Cristina Cardello
Simona Cardinetti

Colour separation:
CD Cromo

Print:
Grafiche Italprint

Si ringrazia:
Apple (CE Group)
Artemide
Books Import
E' Car
Fontana Arte
Greenwitch
Gruppo Sintesi
Muji
Penta
Raffiflora
Siemens
Tappeti Contemporanei

Le opere d'arte presenti nelle immagini sono di:
Virgilio Guidi, Pope, Jorrit Tornquist, Alessandro Verdi

**I divani e le poltrone presenti
nel catalogo sono di Désirée**

CAT. OS 0916



Sport
Design
Art&E



gruppoeuromobil.com



Zalf Mobili Componibili SpA
Via Marosticana, 9
31010 Maser-TV-Italy
Tel. +39 04239255
Fax +39 0423565866
numero verde 800 011019



**Scopri i contenuti extra
con l'app Gruppo Euromobil.**

Scarica la nuova app del
Gruppo Euromobil
dall'Apple Store
o da Google Play.

**Check out the extra content
with Gruppo Euromobil app.**

Download the new
Gruppo Euromobil app
from Apple Store
or Google Play.

Zalf, al fine di migliorare le caratteristiche tecniche e qualitative della sua produzione, si riserva il diritto di modificare in tutto o in parte il contenuto del presente catalogo anche senza preavviso.
Zalf, at the end of improving the technical and qualitative characteristics of production, reserve the right to modify entirely or partially the content of the present catalogue even without notice.
Zalf, au fin de améliorer les caractéristiques techniques et qualitatives de son produit, se réserve le droit de modifier le contenu en tout ou en partie du ce catalogue aussi sans préavis.
Um die technischen und qualitativen Merkmale der Produktion zu verbessern, behält sich Zalf, das Recht vor, den Inhalt des vorliegenden Katalogs ohne Vorankündigung zur Gänze oder teilweise abzuändern.
Zalf, a fin de mejorar sus características y calidad de la producción, se reserva el derecho de hacer cambios completos o parciales en el contenido de este catálogo, incluso sin previo aviso.



Il marchio FSC® identifica prodotti contenente legno proveniente da foreste gestite in maniera corretta e responsabile, secondo rigorosi standards ambientali, sociali ed economici. La foresta di origine è stata controllata e valutata in maniera autonoma in conformità a principi stabiliti ed approvati dal Forest Stewardship Council®.
Zalf SpA, ha scelto per questo catalogo carta certificata FSC®.
The FSC® brand identifies products coming from responsible tree farming, according to very strict environmental, social and economic standards. The forests the wood comes from have been independently controlled and assessed in conformity with the principles established and approved by the Forest Stewardship Council®.
Zalf SpA, has used FSC® certified recycled paper for this catalogue.

Carta: x-per premium white

GRUPPOEUROMOBIL.COM



OFFICE SOLUTION