

SpaceMakers

HOME

DAY

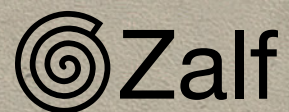

SpaceMakers

HOME

DAY

 Zalf

Headquarter Zalf
"Intimità"
opera di Natalino Andolfatto



SpaceMakers

design R&S Zalf e Roberto Gobbo

Sistemi di arredo che diventano strutture architettoniche fruibili in tutte le aree della casa secondo nuovi schemi abitativi - il design che genera spazio. Elementi di contenimento spesso multifunzionali, sempre più dinamici e ridotti, per rispondere alle esigenze dell'abitare contemporaneo. *Decor systems become architectural structures that can be used throughout the house, as new home design dictates - space-generating design. Storage elements are often multi-purpose, ever more dynamic and compact to meet the needs of a contemporary lifestyle.*

Project concepts	P. 04
Storage units	P. 10
Freespace	P. 36
Windy	P. 70
Flexy Easy	P. 80
Sideboards	P. 88
Tables and Chairs	P. 120
Systems and Fittings	
Storage units	P. 150
Freespace	P. 152
Modulor	P. 160
Windy	P. 162
Flexy Easy	P. 164
Labyrinth	P. 166
Tech	P. 170
Modularity	P. 184
Arrangements and Sizes	P. 190
Finishes	P. 198

Concetti progettuali *Project concepts*

Alla base di ogni creazione Zalf ci sono tre pilastri progettuali che tracciano il percorso verso un design unico: Trasversalità, Spazialità e Versatilità.

There are three design pillars that trace the path to unique design behind every Zalf creation: Transversal, Spacious, Versatile.

Project concepts

Trasversalità *Transversal*

Sistemi living, armadi e cabine armadio, combinabili e compatibili per finiture e dimensionamento, in profondità ed in altezza.
Living room systems as well as walk-in closets and wardrobes, all of which can be combined and are compatible in terms of finishes and sizes, both in depth and height.

Risolvere esigenze diversificate legate alle caratteristiche fisiche dello spazio abitativo attraverso la trasversalità dei sistemi.
Satisfying various requirements linked to the physical characteristics of the spaces available in a home, thanks to the cross-functionality of systems.



Project concepts

Spazialità *Spacious*

Articolare lo spazio generando soluzioni che contengono le funzioni abitative, in modo flessibile e senza la necessità di partiture verticali, con sistemi retrofiniti, accostabili schiena con schiena per tutti i moduli e funzioni, su misura nelle tre dimensioni.

Organising spaces by flexibly generating solutions that contain the functions typical of a home, with no need for vertical partitions, using systems that are finished on the rear or can be fitted back-to-back for all modules and functions and that are available made-to-measure in all three dimensions.

Nello stesso open space, dalle dimensioni contenute di 70 mq, e nella stessa unità residenziale, dalle dimensioni importanti, quattro progetti d'arredo che articolano lo spazio secondo le proprie esigenze ed il proprio gusto. *Four furnishing projects organise spaces to suit the requirements and tastes of users. They are located in the same large residential unit and in the same 70 square metre space.*

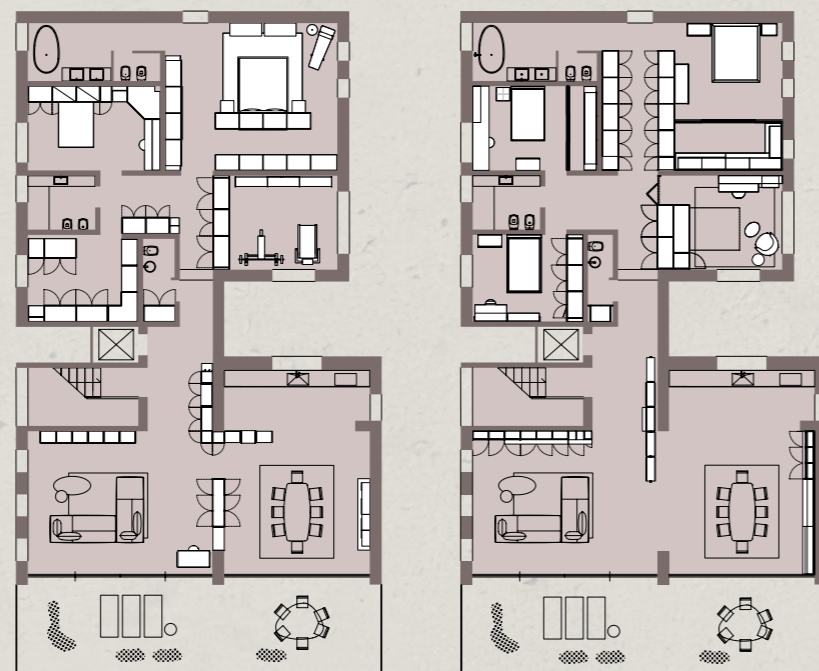
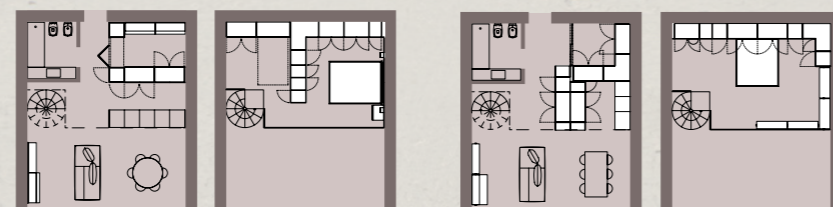

Project concepts

Versatilità *Versatile*

Dare risposte abitative alle famiglie tradizionali, allargate, multigenerazionali alle persone singole e ad altre forme di convivenza. *Offering solutions for the home to traditional, extended and multi-generational families, single people and other types of cohabitation.*

Rispondere a più tipologie abitative prestabilite o trasformative, in quest'ultimo caso consentendo di progettare diverse modalità di utilizzo degli spazi. Dal living allo studio, dalla camera principale alla cabina guardaroba, dagli spazi di connessione ai locali di servizio, differenziando la qualità estetica delle soluzioni progettuali e compiendo sempre scelte giuste, anche nel prezzo.

Meeting the requirements of various types of fixed or transformative homes, in the latter case offering the possibility of planning different ways of using spaces. From the living room to the study, from the master bedroom to the walk-in closet, from corridors to utility rooms, this system lets you differentiate the aesthetic quality of projects so that the right choice can be made at all times.



Index

Storage units



SM2514

P.12



SM2521

P.18



SM2225

P.22

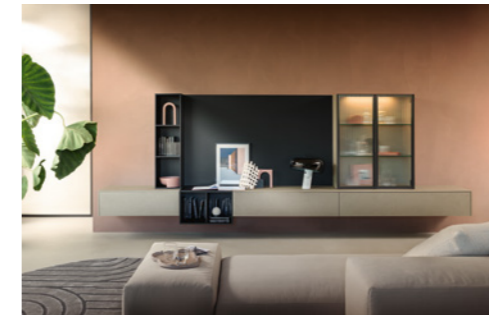

SM2502

P.26



SM2203

P.32

Freespace



SM2520

P.38



SM2212

P.42



SM2522

P.46



SM2501

P.50



SM2200

P.54

Windy

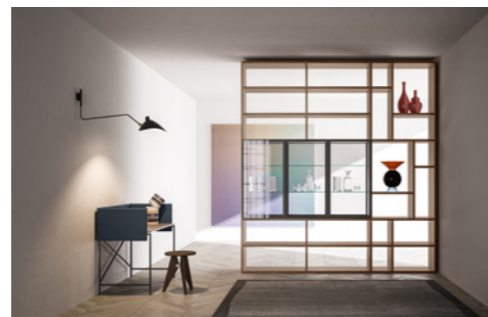

SM2222

P.58

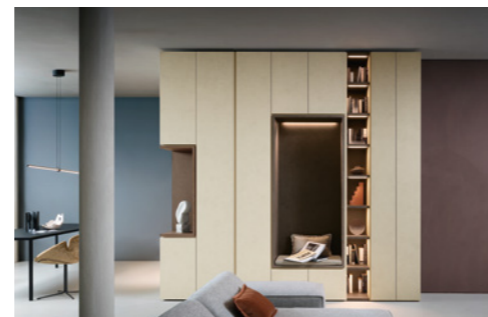

SM2503

P.62



SM2224

P.72



SM2103

P.76



SM2003

P.78

Flexy Easy



SM2205

P.82



SM2006

P.84

Sideboards



P.88

Tables and Chairs



P.120

SM2514





Modulor pannelli opus cemento e noce, mensole in metallo brunito, scrittoio noce. Pensili anta City Glass vetro trasparente fumé e telaio brunito, struttura noce, ripiani interni in vetro. Basi contenitori a terra piano top e copri fianchi sp.1,2 cm noce. Freespace moduli a terra anta Gola opus cemento con nicchia noce e ripiani in vetro. Poltrona Eben e tavolino Dorvan by Desiree.



Opus concrete and walnut Modulor panels, burnished metal shelves, walnut desk. Wall units with City Glass fumé transparent glass doors with a burnished frame, walnut structure, internal glass shelves. Walnut floor-level base storage units and 1.2 cm thick finishing side panels. Freespace floor-level modules with opus concrete Gola doors, a walnut niche, glass shelves. Eben armchair, Dorvan side table by Desiree.



SM2521





Modulor pannelli rovere natural, Unoedue pensili a giorno opus calce, pensile ante City Glass opus calce, vetro trasparente cannettato e telaio brunito; Unoedue base a giorno in appoggio rovere natural, basi sospese opus calce. Divano Lovely Day by Desiree.
Natural oak Modulor panels, opus lime Unoedue open wall units, wall unit with opus lime City Glass doors in transparent fluted glass with a burnished frame; natural oak Unoedue elevated open base unit, opus lime wall-hung base unit. Lovely Day sofa by Desiree.



SM2225





Modulor pannelli carbone, pensili pomice ante City Glass vetro trasparente e telaio brunito, pensili ante ribalta Plana push&pull noce; basi sospese cassettone anta ribalta Plana push&pull noce, Unoedue basi sospese a giorno noce, mensole in metallo brunito.



Coal Modulor panels, pumice wall units with City Glass doors, transparent glass and burnished frames; walnut wall units with Plana push&pull drop-down doors; walnut wall-hung base units with Plana push&pull deep drawer fronts, walnut Unoedue open wall-hung base units, burnished metal shelves.

SM2502







Modular pannelli e Unoedue pensili a giorno carbone, pensile opus cemento con anta City Glass brunito e vetro trasparente cannettato; basi sospese ante ribalta Plana push&pull opus cemento, base sospesa a giorno Unoedue carbone. Coal Modular panels and opus concrete Unoedue open wall unit with City Glass doors in transparent fluted glass with a burnished frame; wall-hung base units with opus concrete Plana push&pull drop-down doors, coal Unoedue open wall-hung base unit.

SM2203





Modulor pannelli carbone, pensili ante Plana push&pull carbone, pensili e base sospesa Unoedue a giorno noce, basi sospese ante ribalta Plana push&pull carbone. Divano Ludwig by Desiree.
Coal Modulor panel; wall units with coal Plana push&pull doors; walnut Unoedue wall units and open wall-hung base units; wall-hung base units with coal, Plana push&pull drop-down doors. Ludwig sofa by Desiree.



Freespace

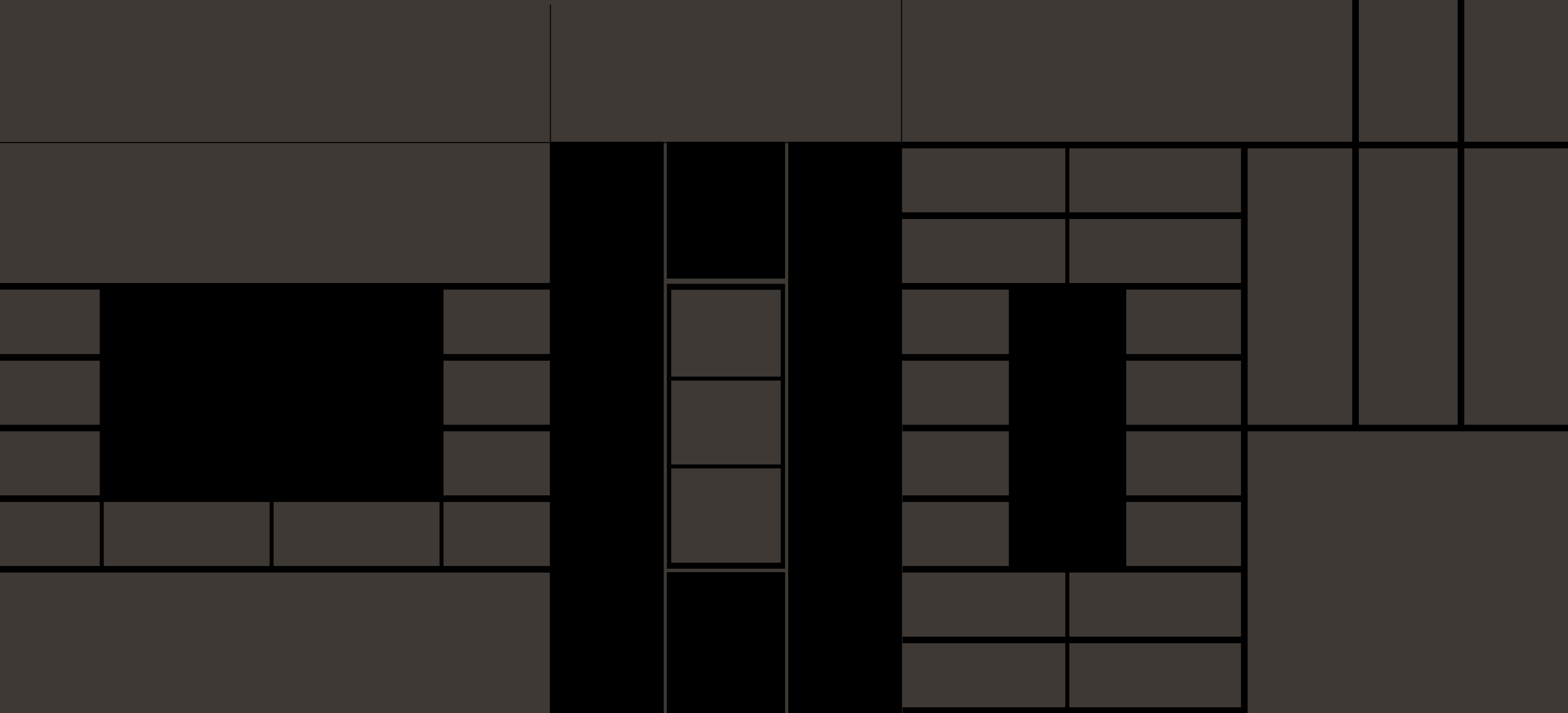

SM2520





Freespace moduli sospesi struttura noce e schiene opus cemento, anta Plana push&pull opus cemento, anta City Glass vetro trasparente cannettato e telaio brunito, modulo sospeso porta TV opus cemento; basi a terra cassettone e ribalta Plana push&pull top e copri fianchi sp. 1,2 cm opus cemento, vassoio noce.



Walnut Freespace wall-hung modules with opus concrete back panels, opus concrete Plana push&pull doors, City Glass doors in transparent fluted glass with a burnished frame, opus concrete wall-hung TV module; floor-level base units, deep drawer and Plana push&pull drop-down doors, opus concrete 1.2 cm thick top and finishing side panels, walnut tray.

SM2212





Freespace moduli sospesi ottanio e carbone con ante City Glass vetro trasparente e telaio brunito, scrittoio carbone.
Freespace octane and coal wall-hung shelving system with transparent glass City Glass doors and burnished frames. Coal desk.

SM2522





Freespace moduli a terra monofacciali anta City Glass vetro trasparente cannettato e telaio brunito, moduli a terra monofacciali con ripiani discontinui bianco talco. Tavolo e sedia Ciàcola by Desiree.
Freespace single-sided floor-level modules, City Glass doors in transparent fluted glass with a burnished frame, single-sided floor-level modules with talc white discontinuous shelves. Ciàcola table and chair by Desiree.



SM2501



Freespace moduli a terra bifacciali con ripiani discontinui rovere natural, ante City Glass vetro trasparente cannettato e telaio brunito. Blunt letto imbottito sfoderabile, tessuto Creta C07, tavolino Tac pomice struttura brunito.
Natural oak Freespace double-sided floor-level modules with discontinuous shelves, City Glass doors in transparent fluted glass with a burnished frame. Blunt upholstered bed in removable Creta C07 fabric, pumice Tac side table with a burnished structure.





LA LETTERATURA LATINA
L'ALCHIMISTA
PAUL CLEAVE NON CI CREDERE

L'ALCHIMISTA
PAUL CLEAVE NON CI CREDERE
FRIEDMAN

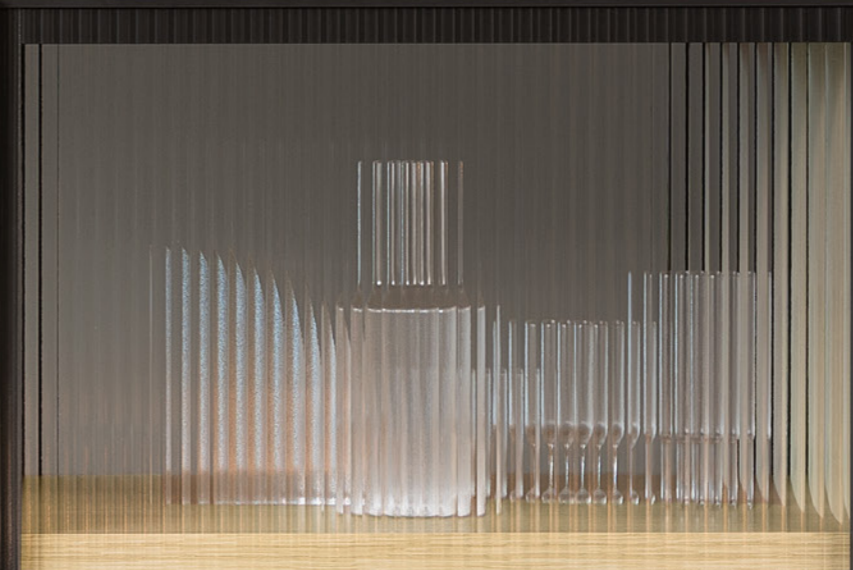

SM2200

Freespace moduli a terra bifacciali
lignum dark con ante City Glass vetro
trasparente fumé e telaio brunito.
*Freespace lignum dark double-sided
floor-level modules featuring City
Glass doors in fumé transparent
glass with a burnished frame.*





SM2222





Freespace sistema a spalla bifacciale noce con ante City Glass vetro trasparente fumé e telaio brunito; Sign scrittoio struttura metallo brunito, piano noce, screen imbottito tessuto Creta C07.
Freespace double-sided shelving system in walnut with City Glass doors in fumé transparent glass with a burnished frame; Sign desk with a burnished metal structure, walnut top, upholstered screen in Creta C07 fabric.



SM2503





Freespace moduli a terra opus calce e opus mattone, nicchia con specchio opus mattone, ante Gola opus calce, ante City Glass vetro trasparente cannettato. Modulo a terra angolo aperto con nicchia ad angolo opus mattone, nicchia con seduta opus mattone, cuscino Creta C1F. Modulo terminale opus calce con anta Plana senza maniglia.



Opus lime and opus brick Freespace floor-level modules, opus brick niche with mirror, opus lime Gola doors, City Glass doors in transparent fluted glass. Open-corner floor-level module with opus brick corner niche, niche with opus brick seat. Creta C1F cushion. Opus lime end module with Plana door without a handle.





Windy



SM2224





Windy sistema con palo a soffitto, mensole carbone, contenitori ante ribalta Plana push&pull noce, contenitori ante vasistas City Glass noce, vetro trasparente fumé e telaio brunito; pannello Siparium tessuto Smack S03 con sacca porta oggetti tessuto Creta C07, scrittoio noce.



Windy system with floor-to-ceiling poles, coal shelves, walnut units with Plana push&pull drop-down doors, walnut wall units with City Glass lift-up doors in fumé transparent glass with a burnished frame; Siparium upholstered panel in Smack S03 fabric, with Creta C07 fabric hanging organisers; walnut desk.

SM2103

Windy sistema con palo a parete, ripiani in vetro Trai 45, contenitori ante vasistas Plana push&pull ardesia, cassetti ante Grip ardesia, profilo brunito. Sign scrittoio struttura metallo brunito, piano vetro brunito opaco. *Windy system with floor-to-wall poles; glass Trai 45 shelves; units with slate Plana push&pull lift-up doors; slate Grip drawer fronts; burnished profile. Sign desk with a burnished metal structure and a matt burnished glass top.*



SM2003



Windy sistema con palo a parete, pali e reggimensole brunito, ripiani Trai 45 con telaio in alluminio brunito e vetro trasparente, piano scrittoio sp.5 cm arena.
Windy system with burnished floor-to-wall poles and shelf brackets, Trai 45 shelves with burnished aluminium frames and transparent glass; 5 cm thick arena desk.



Flexy Easy

SM2205



Flexy Easy sistema a cremagliera brunito con mensole cashmere, contenitori ante vasistas Plana push&pull cashmere, Sign scrittoio struttura in metallo brunito, piano in vetro brunito opaco.
Flexy Easy burnished rack system with cashmere shelves; cashmere storage units with Plana push&pull lift-up doors; Sign desk with a burnished metal structure and a matt burnished glass top.

SM2006





Flexy Easy sistema a cremagliera, montanti e reggimensole brunito, mensole ottanio.
Flexy Easy rack system, burnished metal parts and brackets, octane shelves.



Sideboards

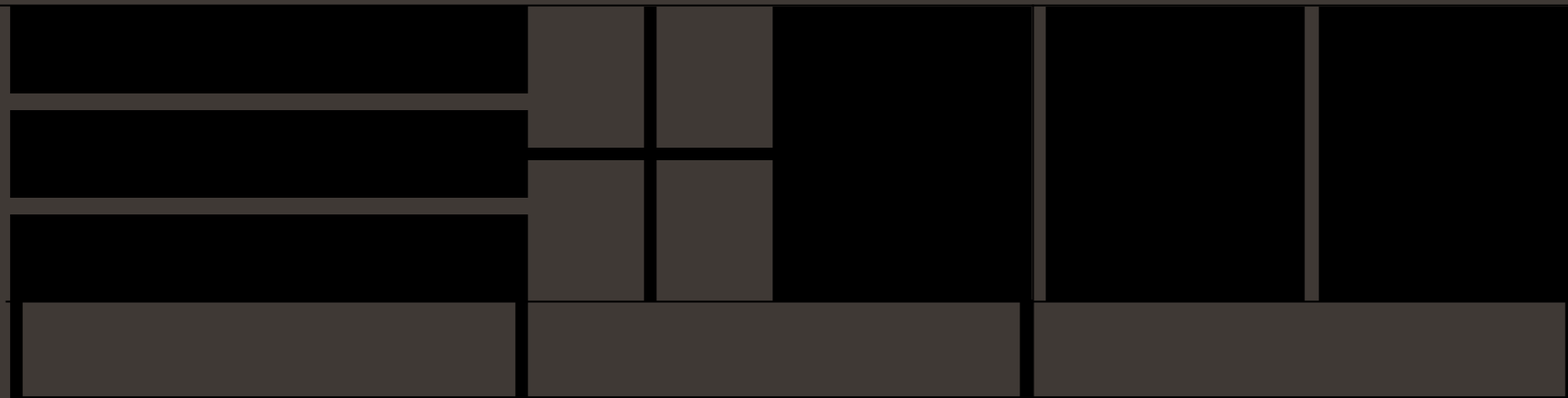





Madia L.270 H. 59,3 cm con basamento componibile brunito, Contenitori ante Grip pomice con profilo brunito; pensili Vuotopieno pomice e carbone.
Sideboard measuring W.270 H.59.3 cm with a burnished modular base, pumice storage units with Grip fronts and burnished profiles; Vuotopieno wall units in pumice and coal.

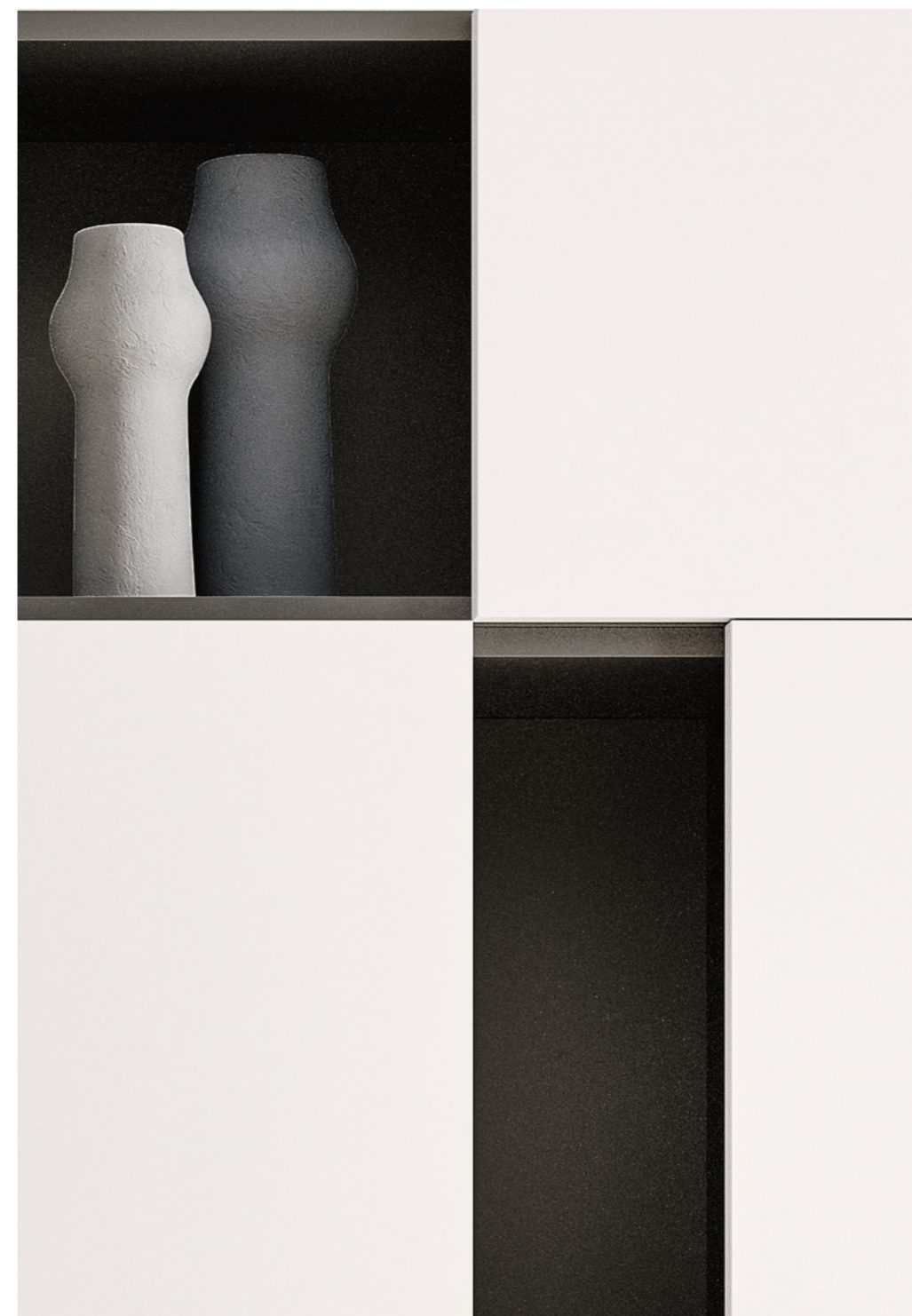



Madia L.240 H.59,3 cm con basamento brunito, top e piano sopra basamento carbone. Contenitori anta Plana push&pull pomice e ante Grip carbone, elemento a giorno opus mattone. Mensola Marker L.120 cm con illuminazione finitura brunito. Sideboard measuring W.240 H.59.3 cm with a burnished base, coal top and base top panel. Storage units feature pumice Plana push&pull doors and coal Grip fronts; opus brick open unit. Marker shelf in burnished finish L.120 cm with lighting.



Madia L.270 H.59,3 cm con basamento componibile brunito, top e piano sopra basamento rovere natural. Contenitori ante Plana rovere natural, ottanio, bianco talco con maniglia Roll brunito, elemento a giorno ottanio. Pensili Unoedue L.180 H.27,6 cm rovere natural. *Sideboard measuring W.270 H.59.3 cm with a burnished modular base, natural oak top and base top panel. Natural oak, octane and talc white units with Plana doors and burnished Roll handles. Octane open unit. Natural oak Unoedue wall units measuring W.180 H.27.6 cm.*



Madia L.270 H.76,5 cm con basamento componibile bianco, top bianco talco. Contenitori anta Plana push&pull e anta Grip bianco talco; terminali interno noce anta battente bianco talco.
Sideboard measuring W.270 H.76.5 cm with a white modular base. Talc white top. Units with Plana push&pull doors and talc white Grip fronts; end units with walnut interiors and talc white hinged doors.



Madia L.270 H.48,9 cm con basamento componibile brunito, top carbone.
Contenitori anta Grip carbone, pomice e profilo brunito. Mensole Marker L.90 cm
con illuminazione, finitura bianco. Nel dettaglio, canala passacavi brunito.
*Sideboard measuring W.270 H.48.9 cm with a burnished modular base and
a coal top. Units with coal and pumice Grip doors, burnished profile. Marker
shelves in white finish L.90 cm with lighting. In the detail, burnished cable grommet.*



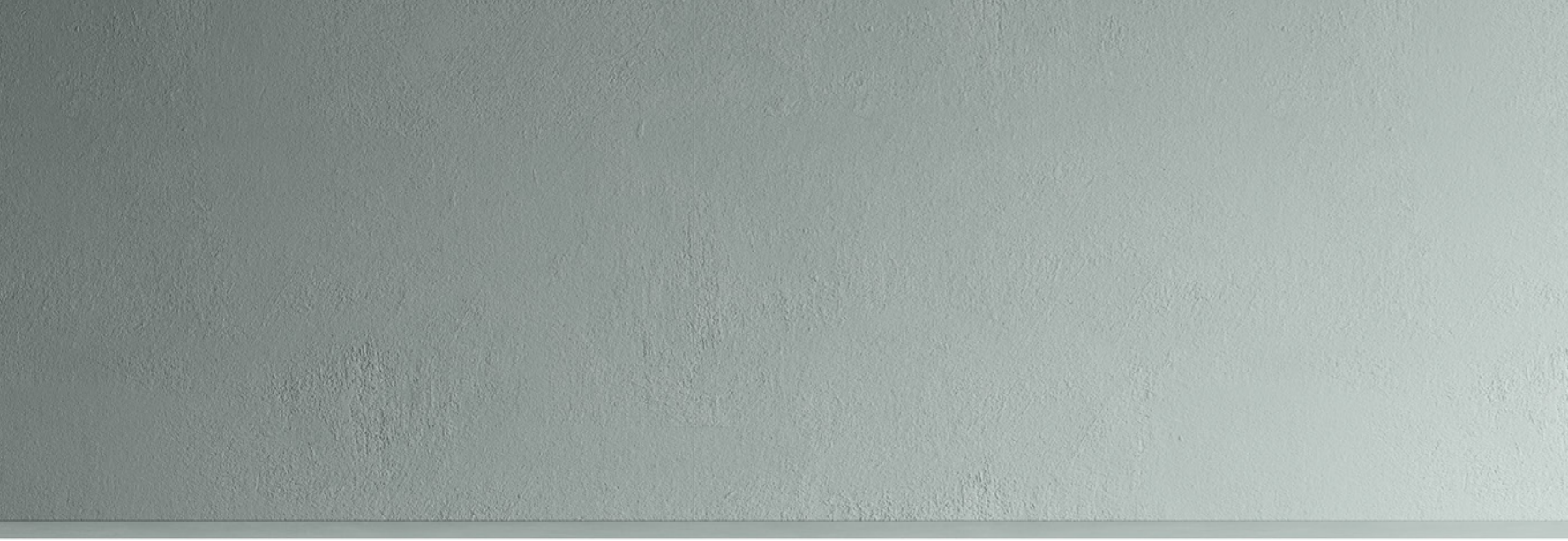

Madia L.270 H.77,7 cm con basamento componibile brunito, top e piano sopra basamento lignum dark. Contenitori anta Plana push&pull bianco talco e anta Plana carbone maniglia Roll brunito, elemento a giorno lignum dark. Sideboard measuring W.270 H.77.7 cm with a burnished modular base, lignum dark top and base top panel. Units with talc white push&pull doors and coal Plana fronts with burnished Roll handles. Lignum dark open unit.



Madia L.240 H.77,7 cm con basamento brunito, top e piano sopra basamento lignum dark.
Contenitori anta Plana opus cemento e pomice maniglia Roll brunito, elemento a giorno lignum dark.
*Sideboard measuring W.240 H.77.7 cm with a burnished base, lignum dark top and base top panel.
Units with opus concrete and pumice Plana doors and burnished Roll handles. Lignum dark open unit.*



Madia L.240 H.59,3 cm con basamento brunito, top e piano sopra basamento opus calce.
Contenitori anta Plana push&pull opus mattone e opus calce, elementi a giorno ottanio e opus mattone.
*Sideboard measuring W.240 H.59.3 cm with a burnished base, opus lime top and base top panel.
Opus brick and opus lime units with Plana push&pull doors, ottanio and opus brick open units.*



Madia L.240 H.58,1 cm con basamento brunito, top opus cemento.
Contenitori anta Plana opus cemento maniglia Roll brunito.
*Sideboard measuring W.240 H.58.1 cm with a burnished base and a opus
concrete top. Units with opus concrete Plana doors and burnished Roll handles.*



Madia L.120 H.76,5 cm con basamento brunito, top opus mattone.
Contenitori anta Plana opus mattone maniglia Roll brunito.
Sideboard measuring W.120 H.76.5 cm with a burnished base and a opus brick top. Units with opus brick Plana doors/fronts and burnished Roll handles.



Madie L.92,6 H.131,7 cm con basamento brunito. Contenitori ante Plana ardesia e bianco talco, maniglia Roll brunito, coprifianchi e top ardesia.
Sideboards measuring W.92.6 H.131.7 cm with a burnished base. Units with slate and talc white Plana fronts, burnished Roll handles, slate finished sides and top.





Madia L. 122,4 H. 131,7 cm con basamento brunito, top e coprifianchi noce. Contenitori anta Plana push&pull e anta Grip bianco talco.
Sideboard measuring W.122.4 H.131.7 cm with a burnished base, walnut top and finishing side panel. Units with Plana push&pull doors and talc white Grip fronts.



Madia L.122,4 H.131,7 cm con basamento brunito, top e coprifianchi
noce. Contenitori anta Plana noce maniglia Roll brunito.
*Sideboard measuring W.122.4 H.131.7 cm with a burnished base, walnut top and
finishing side panels. Units with walnut Plana doors and burnished Roll handles.*



**top
top**

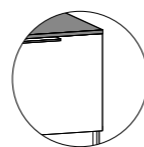

Telaio in metallo 2x2 cm in finitura bianco talco e brunito; contenitori in appoggio P.45,2 cm e top sp.1,2 cm, finiture: bianco talco, pomice, cashmere, arena, selce, ottanio, ardesia, carbone, olmo ash, rovere natural, noce, lignum dark, opus calce, opus cemento, opus mattone.

Metal frame measuring 2x2 cm with a talc white and burnished finish. Elevated 45.2 cm deep units with a 1.2 cm thick top. Finishes: talc white, pumice, cashmere, arena, flint, octane, slate, coal, ash elm, natural oak, walnut, lignum dark, opus lime, opus concrete, opus brick.

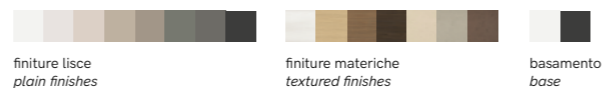

finiture lisce
plain finishes

finiture materiche
textured finishes

basamento
base



**top + piano sopra basamento
top + base top panel**

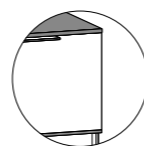

Telaio in metallo 2x2 cm in finitura bianco talco e brunito; contenitori in appoggio P.45,2 cm, top sp.1,2 cm e piano sopra basamento sp.1,2 cm, finiture: bianco talco, pomice, cashmere, arena, selce, ottanio, ardesia, carbone, olmo ash, rovere natural, noce, lignum dark, opus calce, opus cemento, opus mattone.

Metal frame measuring 2x2 cm with a talc white and burnished finish. Elevated 45.2 cm deep units with a 1.2 cm thick top and a 1.2 cm thick base top panel. Finishes: talc white, pumice, cashmere, arena, flint, octane, slate, coal, ash elm, natural oak, walnut, lignum dark, opus lime, opus concrete, opus brick.

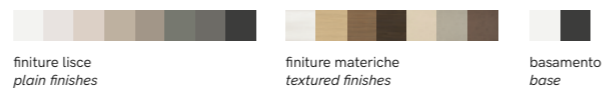

finiture lisce
plain finishes

finiture materiche
textured finishes

basamento
base



**top + coprifianchi
top + finishing side panels**

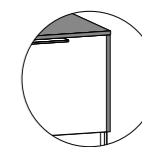

Telaio in metallo 2x2 cm in finitura bianco talco e brunito; contenitori in appoggio P.45,2 cm, top sp.1,2 cm e coprifianchi sp.1,2 cm, finiture: bianco talco, pomice, cashmere, arena, selce, ottanio, ardesia, carbone, olmo ash, rovere natural, noce, lignum dark, opus calce, opus cemento, opus mattone.

Metal frame measuring 2x2 cm with a talc white and burnished finish. Elevated 45.2 cm deep units with a 1.2 cm thick top and 1.2 cm finishing side panels. Finishes: talc white, pumice, cashmere, arena, flint, octane, slate, coal, ash elm, natural oak, walnut, lignum dark, opus lime, opus concrete, opus brick.

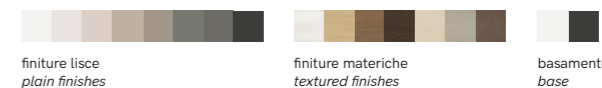

finiture lisce
plain finishes

finiture materiche
textured finishes

basamento
base



**top + piano sopra basamento
+ coprifianchi
top + base top panel
+ finishing side panels**

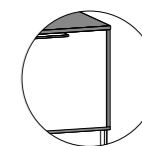

Telaio in metallo 2x2 cm in finitura bianco talco e brunito; contenitori in appoggio P.45,2 cm, top sp.1,2 cm, piano sopra basamento sp.1,2 cm e coprifianchi sp.1,2 cm finiture: bianco talco, pomice, cashmere, arena, selce, ottanio, ardesia, carbone, olmo ash, rovere natural, noce, lignum dark, opus calce, opus cemento, opus mattone.

Metal frame measuring 2x2 cm with a talc white and burnished finish. Elevated 45.2 cm deep units with a 1.2 cm thick top, a 1.2 cm thick base top panel and 1.2 cm thick finishing side panels. Finishes: talc white, pumice, cashmere, arena, flint, octane, slate, coal, ash elm, natural oak, walnut, lignum dark, opus lime, opus concrete, opus brick.

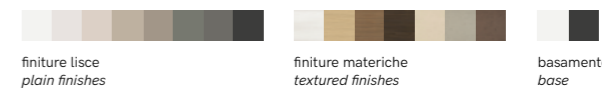

finiture lisce
plain finishes

finiture materiche
textured finishes

basamento
base

Tables and Chairs

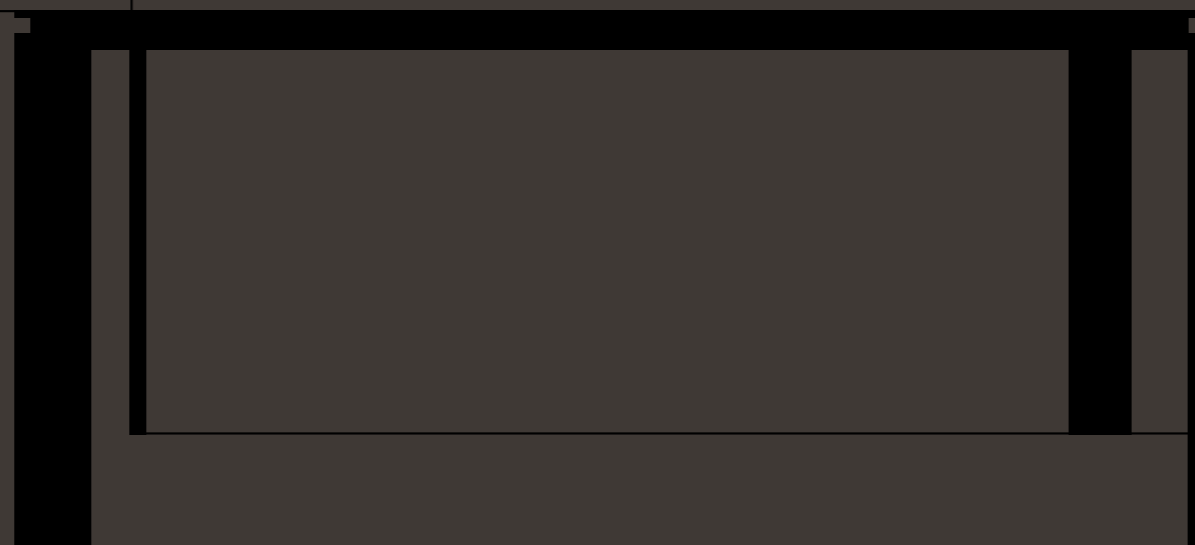



Thin | Kanvas

Tavolo Thin rettangolare in metallo verniciato nero. Sedia Kanvas struttura a traliccio in filo verniciato nero, scocca in tecnopolimero nero.
Thin rectangular table in black painted metal. Kanvas chair with a black-painted, lattice wire structure and a body in black technopolymer.



Thin | Main

Tavolo Thin rettangolare in metallo verniciato nero.
Sedia Main rivestita in ecopelle ignifuga avorio.
*Rectangular Thin table in black-painted metal.
Main upholstered chair in ivory fireproof eco-leather.*



Thin | Isidora

Tavolo Thin rettangolare in metallo verniciato bianco.
Sedia Isidora in tecnopolimero bianco, perla, pistacchio, sabbia.
*Rectangular Thin table in white-painted metal. Isidora chair
in white, pearl grey, pistachio green and sand technopolymer.*



Thin

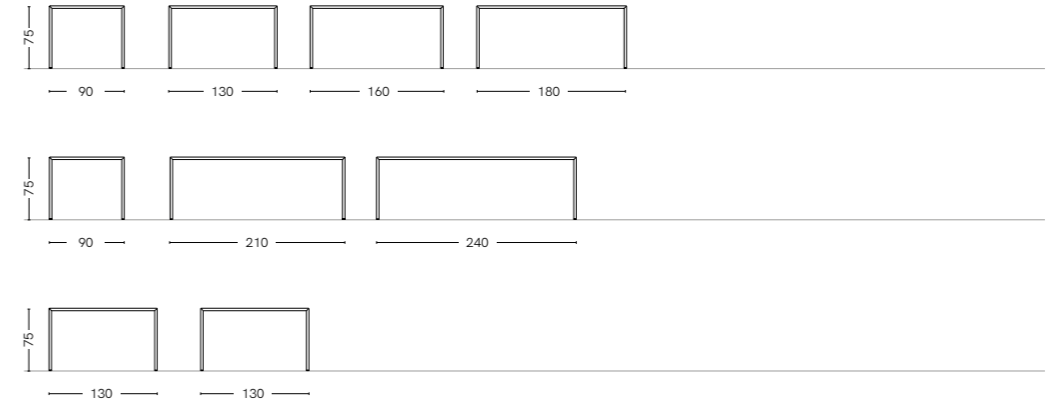

Struttura e piano in metallo verniciato sez.3x3 cm, con piano alleggerito con polistirolo ad alta densità, finiture bianco e nero.
Structure and top in 3x3 cm section, painted metal. The top contains high-density polystyrene which makes it lighter.

struttura
structure



Star | Shell

Tavolo Star struttura e gambe in metallo brunito, piano in opus mattone.
Sedia Shell con struttura in metallo brunito, scocca in pelle testa di moro.
*Star table with burnished metal structure and legs, opus brick top.
Shell chair with burnished metal structure, dark brown leather body.*



Star

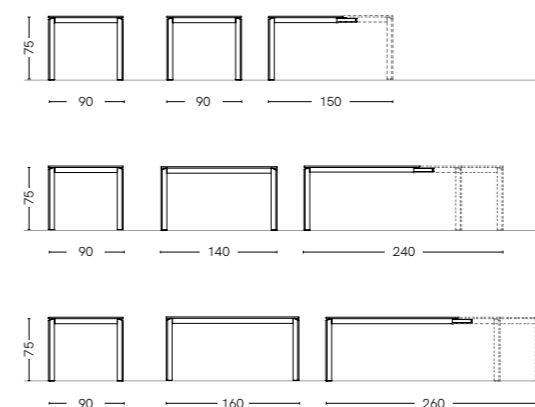

Struttura allungabile e gambe 8x2 cm in metallo in finitura bianco talco e brunito. Piano in melaminico sp.1,8 cm finiture: bianco talco, pomice, cashmere, arena, selce, ottanio, ardesia, carbone, olmo ash, rovere natural, noce, lignum dark, opus calce, opus cemento, opus mattone. *Extending structure and 8x2 cm metal legs with talc white and burnished finish. Melamine top, 1.8 cm thick, in the following finishes: talc white, pumice, cashmere, arena, flint, octane, slate, coal, ash elm, natural oak, walnut, lignum dark, opus lime, opus concrete, opus brick.*

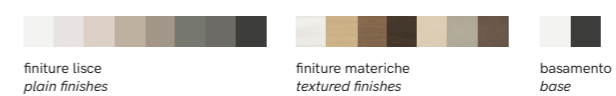



Angolo | Fuller

Tavolo Angolo struttura e gambe in metallo 10x2 cm brunito, piano in vetro lucido brunito. Sedia con braccioli Fuller, struttura a traliccio in filo verniciata in metallo con braccioli, scocca in tecnopolimero nero.
Angolo table with a 10x2 cm burnished metal structure and legs. Glossy burnished glass top. Fuller chair with armrests, a painted metal lattice wire structure with armrests and a black technopolymer body.



Angolo | Bakhita

Tavolo Angolo struttura e gambe in metallo 10x2 cm bianco, piano in melaminico sp.1,8 cm bianco talco. Sedia Bakhita in tecnopolimero sabbia.
Angolo table with a white, 10x2 cm metal structure and legs. 1.8 cm thick, talc white melamine top. Sand technopolymer Bakhita chair.



Angolo

vetro *glass*

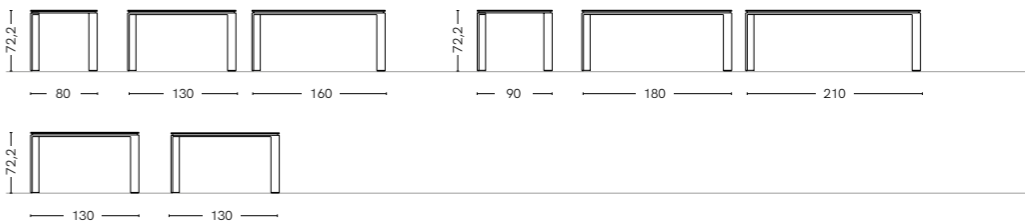

melaminico *melamine*

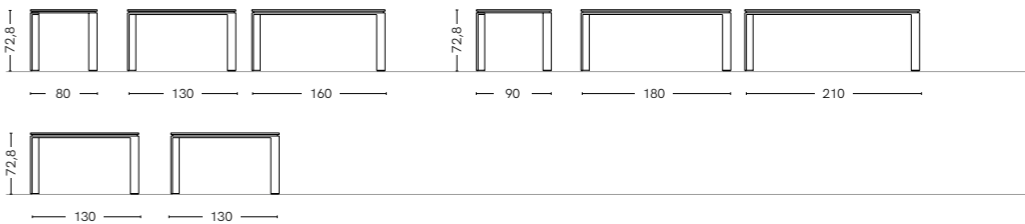

allungabile *extending*

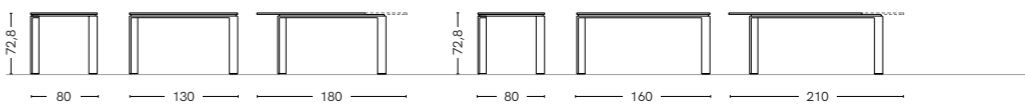

Struttura e gambe 10x2 cm in metallo finiture: bianco talco, brunito; piano in melaminico sp.1,8 cm con bordo ABS 4 lati, finiture: bianco talco, pomice, cashmere, arena, selce, ottanio, ardesia, carbone, olmo ash, rovere natural, noce, lignum dark, opus calce, opus cemento, opus mattone. Modello disponibile con struttura allungabile. Piano in vetro sp.1,2 cm finiture: bianco talco, brunito. *The structure and the 10x2 cm legs are in metal in the following finishes: talc white and burnished. The top is in 1.8 cm thick melamine with an ABS edge on 4 sides, available in the following finishes: talc white, pumice, cashmere, arena, flint, octane, slate, coal, ash elm, natural oak, walnut, lignum dark, opus lime, opus concrete, opus brick. The model is available with an extending structure. 1.2 cm glass top available in the following finishes: talc white and burnished.*

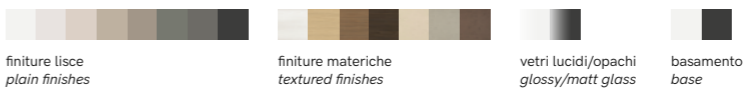



Angolo All | Kanvas

Tavolo Angolo All struttura allungabile e gambe in metallo 10x2 cm bianco, piano in melaminico sp.1,8 cm rovere natural. Sedia Kanvas con struttura a traliccio in filo verniciata bianco, scocca in tecnopolimero bianco.
Angolo extending table with a white, 10x2 cm metal structure and legs. 1.8 cm thick, natural oak melamine top. Kanvas chair with a white-painted, lattice wire structure, white technopolymer body.



Angolo All

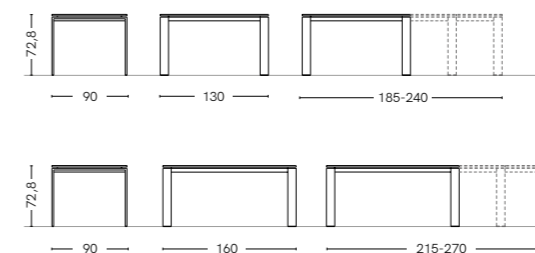

Struttura allungabile e gambe 10x2 cm in metallo finiture: bianco talco, brunito;
 piano in melaminico sp.1,8 cm con bordo ABS 4 lati, finiture: bianco talco,
 pomice, cashmere, arena, selce, ottanio, ardesia, carbone, olmo ash,
 rovere natural, noce, lignum dark, opus calce, opus cemento, opus mattone.
*The extending structure and the 10x2 cm legs are in metal in the following finishes:
 talc white and burnished. The top is in 1.8 cm thick melamine with an ABS edge
 on 4 sides in the following finishes: talc white, pumice, cashmere, arena, flint, octane, slate,
 coal, ash elm, natural oak, walnut, lignum dark, opus lime, opus concrete, opus brick.*

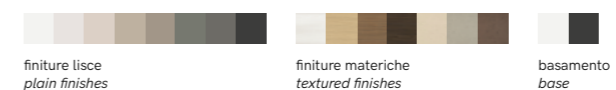



Minimus | Compass

Tavolo Minimus struttura gambe in metallo 5x5 cm brunito, piano in melaminico sp.1,8 cm carbone.
Sedia Compass, struttura in metallo brunito, seduta imbottita rivestita in ecopelle testa di moro.

Minimus table burnished, 5x5 cm metal legs and structure and a 1.8 cm thick coal melamine top.

Compass chair with a burnished metal structure and a padded seat upholstered in dark brown eco-leather.



Minimus



Struttura e gambe in metallo, finiture: bianco talco, brunito; sezione quadra 5x5 cm; piano in melaminico sp.1.8 cm, finiture: bianco talco, pomice, cashmere, arena, selce, ottanio, ardesia, carbone, olmo ash, rovere natural, noce, lignum dark, opus calce, opus cemento, opus mattone.
The structure and legs are in metal in the following finishes: talc white and burnished; 5x5 cm thick, square cross-section; the top is in 1.8 cm thick melamine in the following finishes: talc white, pumice, cashmere, arena, flint, octane, slate, coal, ash elm, natural oak, walnut, lignum dark, opus lime, opus concrete, opus brick.

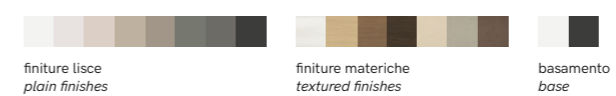

Systems and Fittings

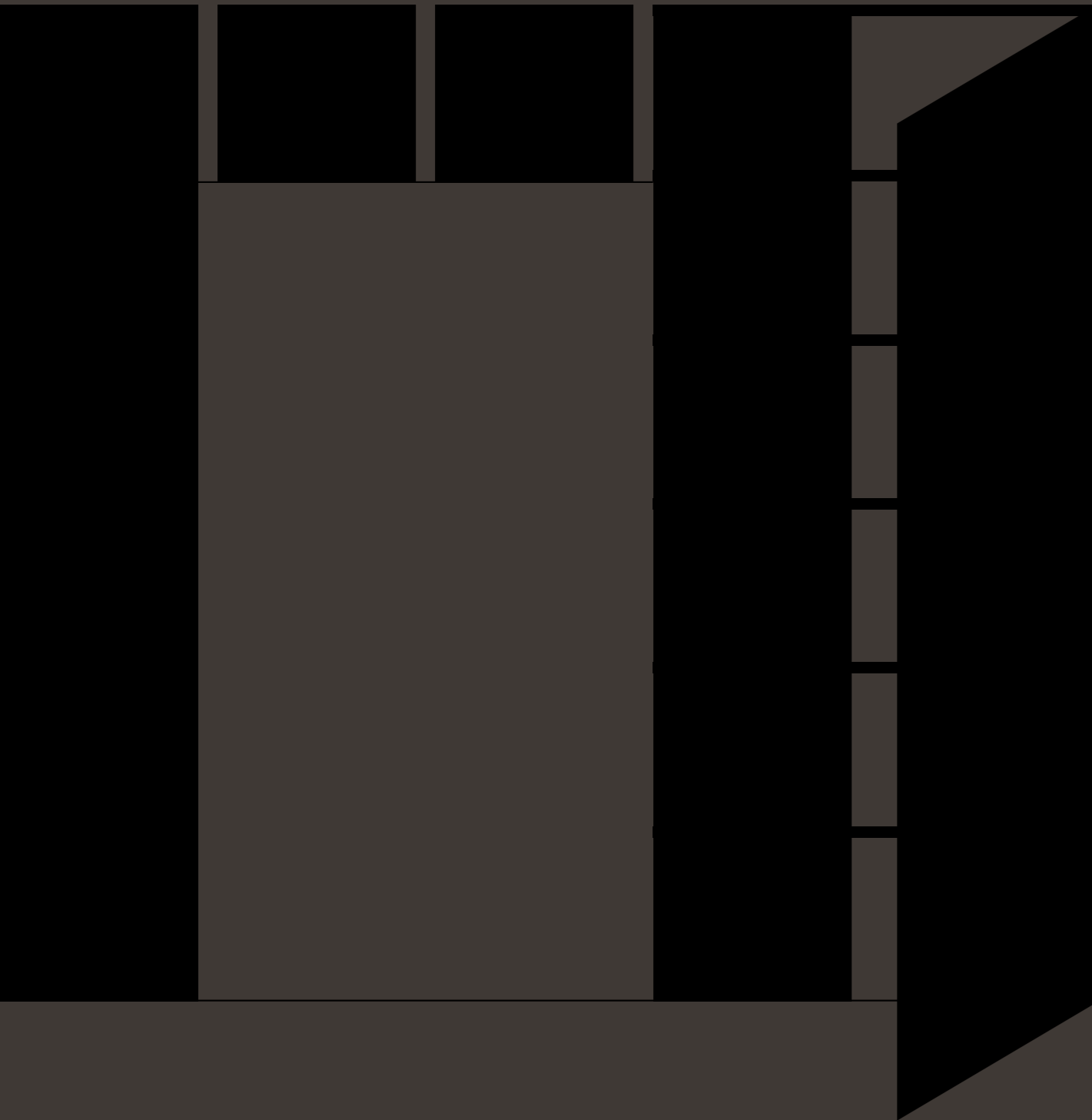

Storage units



1. Vuotopieno pensili con unione a 45° e ante asimmetriche. *Vuotopieno wall units with 45° joints and asymmetric fronts.* **2. Base** in appoggio anta battente Plana maniglia Roll, fianchi e cappelli sp.18 mm. *Elevated base units with Plana hinged doors, Roll handles, 18 mm thick side and top panels.* **3. Pensili** fianchi e cappelli sp.18 mm anta battente City Glass. *Wall units with 18 mm thick side and top panels, City Glass hinged door.* **4. Base** a terra con vassoio anta ribalta Plana push&pull fianchi e cappelli sp.18 mm. *Floor-level base unit with tray, Plana push&pull drop-down door and 18 mm thick sides and top panels.* **5. Z45** pensili con unione a 45° anta a ribalta e vasistas Plana. *Z45 wall units with 45° joints and Plana drop-down and lift-up doors.* **6. Z45** base sospesa con unione a 45° anta a ribalta Plana push&pull. *Z45 wall-hung base unit with 45° joints and Plana push&pull drop-down door.* **7. Unoedue** pensili con fianchi e cappelli sp.12 mm. *Unoedue wall units with 12 mm thick side and top panels.* **8. Unoedue** base sospesa con fianchi e cappelli sp.12 mm. *Unoedue wall-hung base unit with 12 mm thick side and top panels.* **9. Base** sospesa anta Grip, fianchi e cappelli sp.18 mm. *Wall-hung base unit with Grip door, 18 mm thick side and top panels.* **10. Pensili** fianchi e cappelli sp.18 mm a giorno e con anta battente Gola. *Wall units with 18 mm thick side and top panels, one open and one with a Gola hinged door.*

basi base units

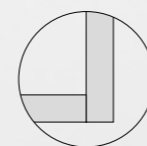

sp.12 mm
18 mm thick

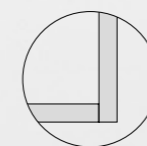

UNOEDUE
basi sp.12 mm
base unit with
12 mm thick

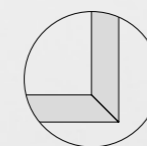

Z45
basi unione 45°
base unit with 45°
joints

pensili wall units

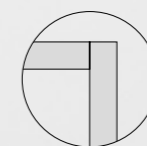

sp.12 mm
18 mm thick

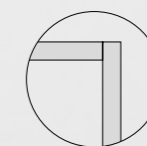

UNOEDUE
pensili sp.12 mm
wall unit with
12 mm thick

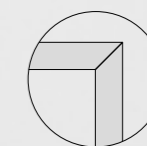

Z45
pensili unione 45°
wall unit
with 45° joints

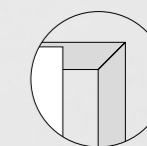

VUOTOPIENO
pensili unione 45°
ante asimmetriche
wall units with
45° joints and
asymmetric fronts

Freespace



1. Terminale sospeso. *Wall-hung end unit.* 2. Modulo sospeso. *Wall-hung module.* 3. Modulo in appoggio. *Sit-on module.* 4. Modulo a terra. *Floor-level module.* 5. Nicchia monofacciale. *Single-sided niche.* 6. Modulo tv a terra con vano a giorno. *Floor-level TV module with open compartment.* 7. Elementi divisori e a C monofacciali. *Dividers and single-sided C-shaped elements.* 8. Scala in metallo. *Metal ladder.* 9. Modulo letto a ribalta con divano. *Wall bed module with sofa.* 10. Angolo aperto. *Open corner unit.* 11. Nicchia ad angolo. *Corner niche.* 12. Tramezza sp.28 mm. *28 mm thick partition.* 13. Modulo angolo bifacciale. *Double-sided corner module.* 14. Modulo a terra bifacciale. *Double-sided floor-level module.* 15. Ponte bifacciale. *Double-sided overhead unit.* 16. Nicchia bifacciale. *Double-sided open niche.*

Freespace

Barra sottoponte *Overhead unit bar*

Due barre in metallo scatolate da un pannello di chiusura H.7,9 cm disponibile in tutte le finiture.
Two metal bars enclosed in a 7.9 cm high panel available in all our finishes.



Scala *Ladder*

Scala in metallo brunito con sistema di scorrimento su binario fissato ai fianchi.
Ladder in burnished metal with sliding track fixed to the side panels.



Freespace

Modulo letto a ribalta con divano
Fold-away bed module with sofa



Inquadra il QR Code per specifiche
sui sistemi di apertura
*Scan the QR Code for specifications
regarding opening systems*

Modulo letto a ribalta con divano bracciolo sp.3 cm disponibile in due misure: L.130,5 (rete L.120x200) e L.170,5 (rete L.160x200) e in due altezze 222,4 o 259,2; ai lati elementi a giorno.
Folding bed module with sofa featuring 3 cm wide armrests, available in two sizes: W.130.5 (bed base W.120x200) and W.170.5 (bed base W.160x200) and in two heights 222.4 or 259.2. Flanked by open units.

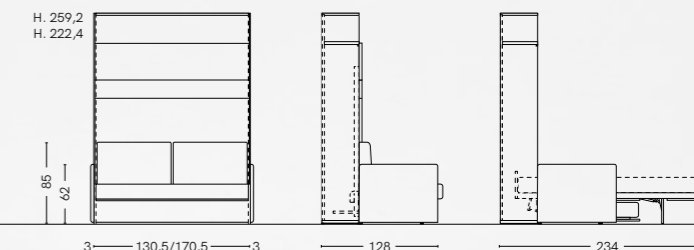

Freespace

Modulo letto a ribalta con divano
Fold-away bed module with sofa



Inquadra il QR Code per specifiche
sui sistemi di apertura
*Scan the QR Code for specifications
regarding opening systems*

Modulo letto a ribalta con divano bracciolo sp.15 cm disponibile
in due misure: L.130,5 (rete L.120x200) e L.170,5 (rete L.160x200)
e in due altezze 222,4 o 259,2; ai lati elementi a giorno.
*Folding bed module with sofa featuring 15 cm wide armrests,
available in two sizes: W.130.5 (bed base W.120x200) and W.170.5
(bed base W.160x200) and in two heights 222.4 or 259.2. Flanked
by open units.*

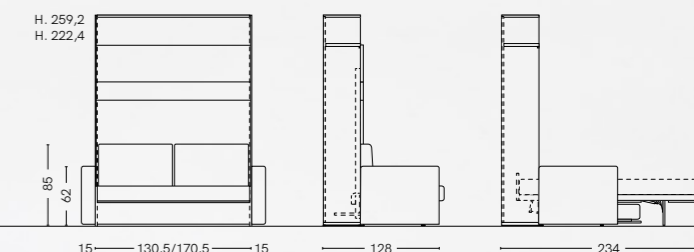

Modulor



1. Mensola in metallo. *Metal shelf.* 2. Scrivania P.45,5. *Desk D.45.5.* 3. Contenitore anta battente City Glass. *Unit with City Glass hinged door.* 4. Contenitore anta battente Plana push&pull. *Unit with Plana push&pull hinged door.* 5. Contenitore anta a ribalta Plana push&pull. *Unit with Plana push&pull drop-down door.* 6. Contenitore anta battente Gola. *Unit with Gola hinged door.* 7. Cassetti Grip. *Grip drawers.* 8. Contenitore anta a ribalta City Glass. *Unit with City Glass drop-down door.*

Windy



1. Pannello imbottito Siparium. *Siparium padded panel.* 2. Contenitori anta ribalta Plana con ante di finitura retro. *Unit with Plana drop-down doors and rear finishing panels.* 3. Contenitore anta vasistas Plana. *Unit with Plana lift-up door.* 4. Pannello porta TV. *TV panel.* 5. Cassetti Grip. *Grip drawers.* 6. Scrittoio. *Desk.* 7. Elemento a giorno. *Open unit.* 8. Vassoio Trai 45 frontalino in melaminico. *Trai 45 tray with melamine front.* 9. Contenitore anta battente Gola. *Unit with Gola hinged doors.* 10. Ripiano Trai 45. *Trai 45 shelf.* 11. Contenitore anta vasistas City Glass. *Unit with City Glass lift-up door.* 12. Vassoio Trai 45 frontalino in vetro. *Trai 45 tray with glass front.* 13. Contenitore anta battente City Glass. *Unit with City Glass hinged door.* 14. Vassoio e portapantaloni Trai 45 frontalino in melaminico. *Trai 45 tray and trousers rack in melamine.* 15. Servetto. *Clothes-lift.* 16. Portacamicie. *Shirt shelves.* 17. Mensola portascarpe. *Shoes shelf.*

Flexy Easy



1. Portacamicie. *Shirt shelves.* 2. Mensola portascarpe. *Shoes shelf.* 3. Vassoio Trai 45 frontalino in melaminico. *Trai 45 tray with melamine front.* 4. Contenitore anta battente Gola. *Unit with Gola hinged doors.* 5. Vassoio Trai 45 frontalino in vetro. *Trai 45 tray with glass front.* 6. Cassetti e cassettoni Grip. *Grip drawers and deep drawers.* 7. Vassoio e portapantaloni Trai 45 frontalino in vetro. *Trai 45 tray and trousers rack with glass front.* 8. Ripiano Trai 45 in vetro con appendiabiti. *Trai 45 shelf in glass with hanging rail.* 9. Cassetti Plana maniglia Roll. *Plana drawers with Roll handle.* 10. Mensole P.30. *Shelves D.30.* 11. Contenitore anta ribalta Plana con boccola passacavi. *Unit with Plana bottom-hung door and cable grommet.* 12. Elemento a giorno. *Open unit.* 13. Contenitore anta vasistas City Glass. *Unit with City Glass lift-up door.* 14. Ripiano Trai 45 in vetro. *Trai 45 glass shelf.*

Labyrinth

Pannelli tessili per organizzare lo spazio liberamente
Fabric panels to organise space



Labyrinth

pannelli tessili
fabric panels

Pannelli tessili sp.6 cm in tre differenti misure, small L.69 cm, medium L.112 cm e large L.138 cm, imbottiti e rivestiti in tessuto o ecopelle sfoderabile. Piastra metallica 36x18 sp.0,5 cm e cerniere in metallo finitura brunito. *6cm thick fabric panels in three different sizes, small L. 69cm, medium L.112cm and large L. 138cm, padded and upholstered in removable fabric or ecoleather. 36x18 x0.5cm thick metal plate, metal hinge with burnished finish.*

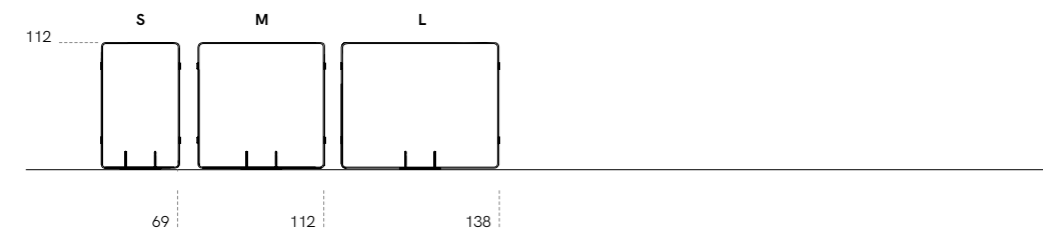

composizioni tipo
typical compositions

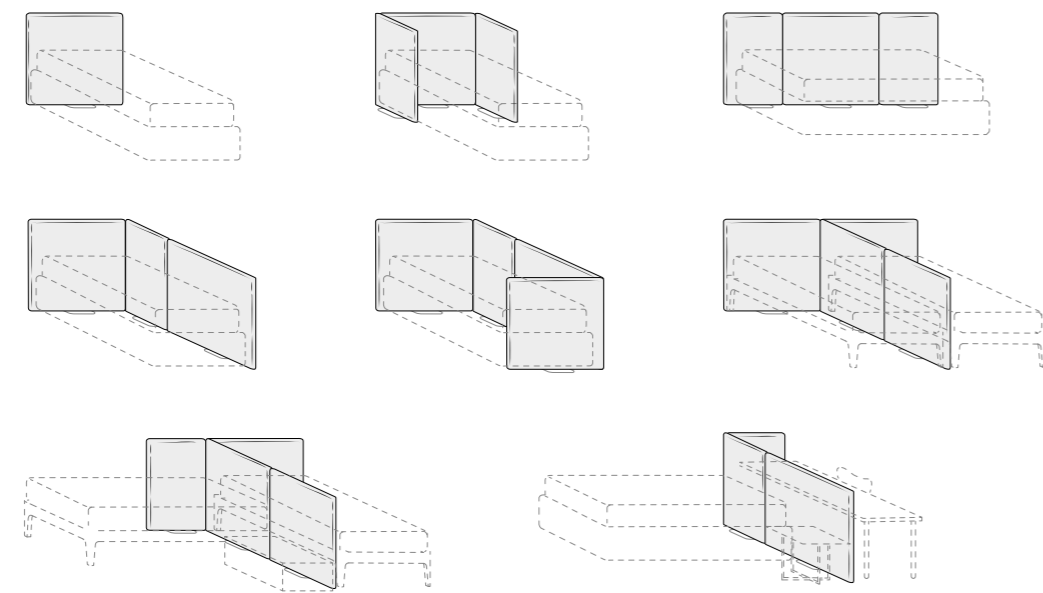

Tech



Ante battenti, ribalta
e vasistas per contenitori
e libreria a spalla portante
*Hinged, drop-down and
lift-up doors for shelving
system units and bookcases*



Plana

ante battenti
hinged doors

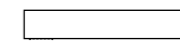

Anta battente, ribalta o vasistas per contenitori e libreria a spalla composta da pannello nobilitato in agglomerato di legno sp.2,2 cm. Maniglia a scelta tra quelle per anta Plana o apertura push&pull. Finiture: bianco talco, pomice, cashmere, arena, selce, ottanio, ardesia, carbone, olmo ash, rovere natural, noce, lignum dark, opus calce, opus cemento, opus mattone.

Hinged, drop-down or lift-up doors for shelving units and systems composed of 2.2 cm thick, melamine-faced wood composite panels. Choose between push&pull opening or handle for Plana door. Finishes: talc white, pumice, cashmere, arena, flint, octane, slate, coal, ash elm, natural oak, walnut, lignum dark, opus lime, opus concrete, opus brick.

cassetti, ante ribalta e vasistas
drawers, drop-down and lift-up doors

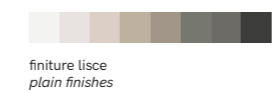
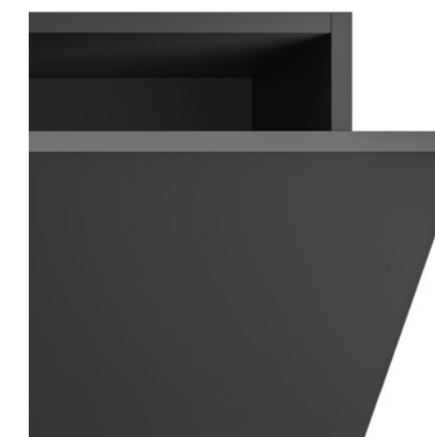

finiture lisce
plain finishes



finiture materiche
textured finishes

Gola / Grip

GOLA
ante battenti
hinged doors

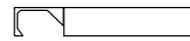

Anta battente, ribalta o vasistas per contenitori e libreria a spalla composta da pannello nobilitato in agglomerato di legno sp.2,2 cm. Finiture: bianco talco, pomice, cashmere, arena, selce, ottanio, ardesia, carbone, olmo ash, rovere natural, noce, lignum dark, opus calce, opus cemento, opus mattone. Profilo Gola e profilo Grip finitura bianco talco, pomice, cashmere, arena, selce, ottanio, ardesia, carbone, opus calce, opus cemento, opus mattone o brunito.

Hinged, drop-down or lift-up doors for units and shelving systems, composed of 2.2 cm thick, melamine-faced wood composite panels. Finishes: talc white, pumice, cashmere, arena, flint, octane, slate, coal, ash elm, natural oak, walnut, lignum dark, opus lime, opus concrete, opus brick. The Gola and Grip profiles are available in the following finishes: talc white, pumice, cashmere, arena, flint, octane, slate, coal, opus lime, opus concrete, opus brick or burnished.

GRIP
cassetti, ante ribalta e vasistas
drawers, drop-down and lift-up doors

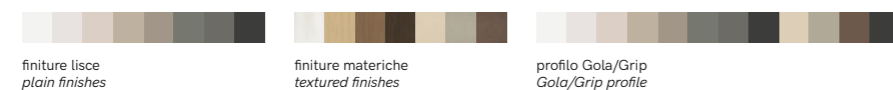
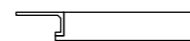

finiture lisce
plain finishes

finiture materiche
textured finishes

profilo Gola/Grip
Gola/Grip profile

City Glass

ante battenti
hinged doors



Anta battente, ribalta o vasistas per contenitori e libreria a spalla composta da telaio alluminio con maniglia integrata e cerniere portanti in finitura brunito, vetro temperato sp.0,4 cm trasparente, trasparente fumé, riflettente chiaro o cannettato trasparente.

Hinged, drop-down or lift-up doors for units and shelving systems made up of an aluminium frame with an integrated handle and load-bearing hinges with a burnished finish. Available in 0.4 cm thick tempered transparent, fumé transparent, clear reflecting glass or transparent fluted glass.

cassetti, ante ribalta e vasistas
drawers, drop-down and lift-up doors



vetro temperato
tempered glass

telaio
frame

**Maniglie per anta
e cassetto Plana**
*Handles for Plana
doors and drawers*



Push&Pull



Ring

L.8 H.8 P.2,2



Ellipse

L.6 H.12 P.3,5



Finiture: bianco talco, pomice, cashmere.
Finishes: talc white, pumice, cashmere.



Finiture: bianco talco, pomice, cashmere.
Finishes: talc white, pumice, cashmere.

Tipo R

Ø3,9 P.2,2



Quadra

L.7 H.7 P.2,5



Roll

Ø1,2 P.3



Finiture: bianco talco, pomice, cashmere,
arena, selce, ottanio, ardesia, carbone.
Finishes: talc white, pumice, cashmere,
arena, flint, octane, slate, coal.



Finiture: bianco talco, pomice, cashmere.
Finishes: talc white, pumice, cashmere.



Finiture: bianco talco, brunito.
Finishes: talc white, burnished.

Lalass L.0,5 H.15 P.2



Finiture: bianco talco, 0 chimico, brunito.
Finishes: talc white, 0 aluminium, burnished.

Plan L.1 H.13,8 P.2



Finiture: bianco talco, 0 chimico, brunito.
Finishes: talc white, 0 aluminium, burnished.

Inclina L.3,9 H.19,2 P.2,2

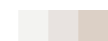

Finiture: bianco talco, pomice, cashmere.
Finishes: talc white, pumice, cashmere.

Shanghai L.1,7 H.14,9 P.2,4



Finiture: bianco talco, pomice, cashmere,
arena, selce, ottanio, ardesia, carbone.
Finishes: talc white, pumice, cashmere,
arena, flint, octane, slate, coal.

Tipo C L.2 H.15,8 P.2



Finiture: bianco talco.
Finishes: talc white.

Cilindro L.2 H.25,4 P.2



Finiture: bianco talco, brunito.
Finishes: talc white, burnished.

Ruler L.1,5 H.24 P.2



Finiture: bianco talco, pomice, cashmere,
arena, selce, ottanio, ardesia, carbone, olmo
ash, rovere natural, noce, lignum dark.
Finishes: talc white, pumice, cashmere,
arena, flint, octane, slate, coal, ash elm,
natural oak, walnut, lignum dark.

Plan L.1 H.23,4 P.2



Finiture: bianco talco, 0 chimico, brunito.
Finishes: talc white, 0 aluminium, burnished.

Virgola L.3,1 H.19,2 P.3



Finiture: bianco talco, pomice, cashmere,
arena, selce, ottanio, ardesia, carbone, olmo
ash, rovere natural, noce, lignum dark.
Finishes: talc white, pumice, cashmere,
arena, flint, octane, slate, coal, ash elm,
natural oak, walnut, lignum dark.

Shanghai L.1,7 H.30,8 P.2,4



Finiture: bianco talco, pomice, cashmere,
arena, selce, ottanio, ardesia, carbone.
Finishes: talc white, pumice, cashmere,
arena, flint, octane, slate, coal.

Bridge L.1,5 H.23,9 P.3,7



Finiture: bianco talco, 0 chimico, brunito.
Finishes: talc white, 0 aluminium, burnished.

Bench L.1,6 H.30,4 P.3,4



Finiture: bianco talco, pomice, cashmere,
arena, selce, ottanio, ardesia, carbone, olmo
ash, rovere natural, noce, lignum dark.
Finishes: talc white, pumice, cashmere,
arena, flint, octane, slate, coal, ash elm,
natural oak, walnut, lignum dark.

Tipo F L.1 H.16,8 P.2



Finiture: bianco talco, pomice, cashmere, arena, selce, ottanio, ardesia, carbone, olmo ash, rovere natural, noce, lignum dark.
Finishes: talc white, pumice, cashmere, arena, flint, octane, slate, coal, ash elm, natural oak, walnut, lignum dark.

Tipo G L.1,6 H.15 P.4



Finiture: 0 chimico.
Finishes: 0 aluminium.

Tipo L L.1 H.13,8 P.4



Finiture: bianco talco, 0 chimico, brunito.
Finishes: talc white, 0 aluminium, burnished.

Tipo M L.2,5 H.15,3 P.2,5



Finiture: bianco talco, pomice, cashmere, arena, selce, ottanio, ardesia, carbone.
Finishes: talc white, pumice, cashmere, arena, flint, octane, slate, coal.

Tipo G L.1,6 H.91,8 P.4



Finiture: 0 chimico.
Finishes: 0 aluminium.

Tipo M L.2,5 H.92,1 P.2,5



Finiture: bianco talco, pomice, cashmere, arena, selce, ottanio, ardesia, carbone.
Finishes: talc white, pumice, cashmere, arena, flint, octane, slate, coal.

Tipo F L.1 H.24,6 P.2



Finiture: bianco talco, pomice, cashmere, arena, selce, ottanio, ardesia, carbone, olmo ash, rovere natural, noce, lignum dark.
Finishes: talc white, pumice, cashmere, arena, flint, octane, slate, coal, ash elm, natural oak, walnut, lignum dark.

Tipo G L.1,6 H.24,6 P.4



Finiture: 0 chimico.
Finishes: 0 aluminium.

Tipo L L.1 H.23,4 P.4



Finiture: bianco talco, 0 chimico, brunito.
Finishes: talc white, 0 aluminium, burnished.

Tipo M L.2,5 H.24,9 P.2,5



Finiture: bianco talco, pomice, cashmere, arena, selce, ottanio, ardesia, carbone.
Finishes: talc white, pumice, cashmere, arena, flint, octane, slate, coal.

Ruler L.1,5 H.100,8 P.2



Finiture: bianco talco, pomice, cashmere, arena, selce, ottanio, ardesia, carbone, olmo ash, rovere natural, noce, lignum dark.
Finishes: talc white, pumice, cashmere, arena, flint, octane, slate, coal, ash elm, natural oak, walnut, lignum dark.

Virgola L.3,1 H.105,6 P.3



Finiture: bianco talco, pomice, cashmere, arena, selce, ottanio, ardesia, carbone, olmo ash, rovere natural, noce, lignum dark.
Finishes: talc white, pumice, cashmere, arena, flint, octane, slate, coal, ash elm, natural oak, walnut, lignum dark.

Inclina L.3,9 H.105,6 P.2,2



Finiture: bianco talco, pomice, cashmere.
Finishes: talc white, pumice, cashmere.

Bridge L.1,5 H.100,7 P.3,7



Finiture: bianco talco, 0 chimico, brunito.
Finishes: talc white, 0 aluminium, burnished.

Ogiva L.0,7 H.105,6 P.2,8



Finiture: bianco talco, 0 chimico, brunito.
Finishes: talc white, 0 aluminium, burnished.

Cilindro L.2 H.102,2 P.2



Finiture: bianco talco, brunito.
Finishes: talc white, burnished.

Modularity

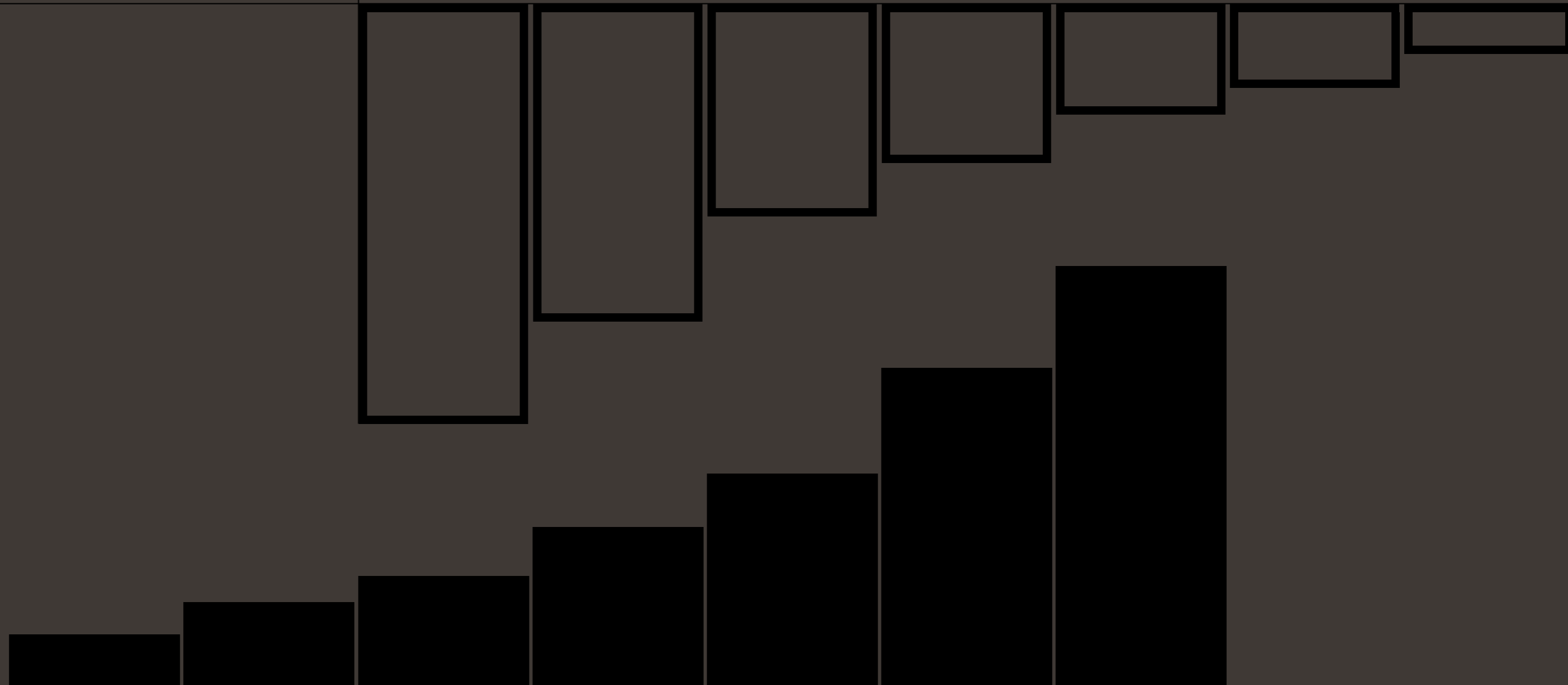

Basi

Base units

Basi contenitori

Base storage units

A TERRA E IN APPOGGIO
FLOOR-LEVEL AND ELEVATED

P.32,4 - 45,2 - 61,2

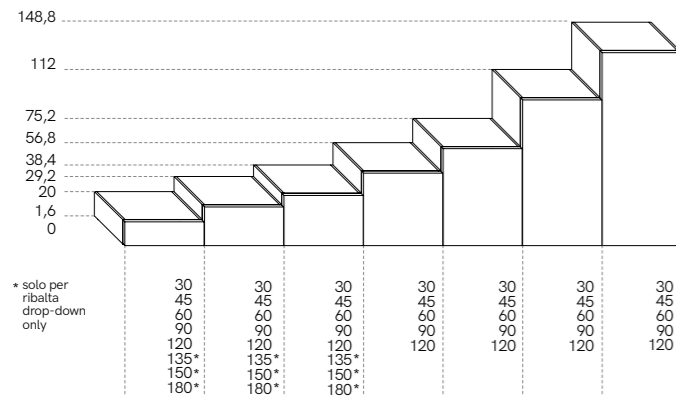

SOSPESA
WALL-HUNG

P.32,4 - 45,2

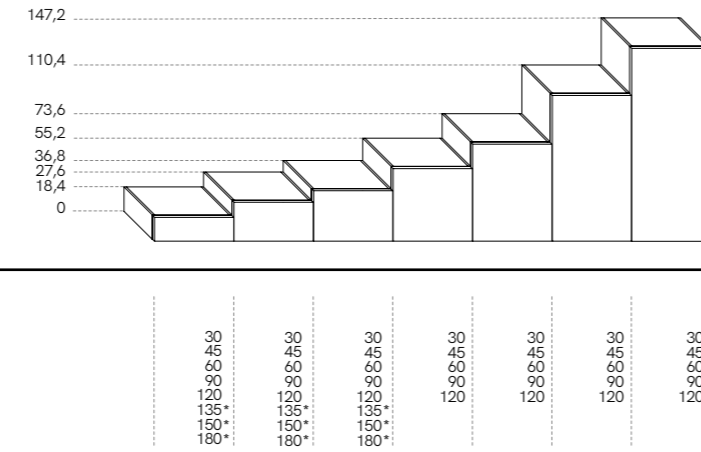

UNOEDUE

Basi sospese e in appoggio

Wall-hung and elevated base units

P.45,2

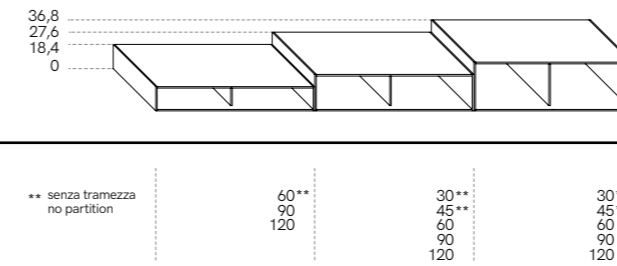

Z45

Basi sospese

Wall-hung base units

P.45,2

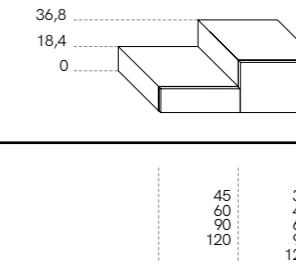

Pensili

Wall units

Pensili

Wall units

P.32,4 - 45,2

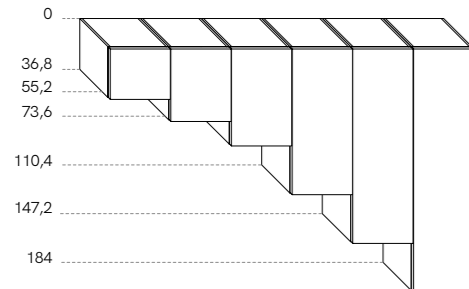

VUOTOPIENO

Pensili

Wall units

P.32,4 - 45,2

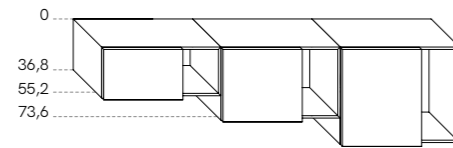

Z45

Pensili

Wall units

P.32,4 - 45,2

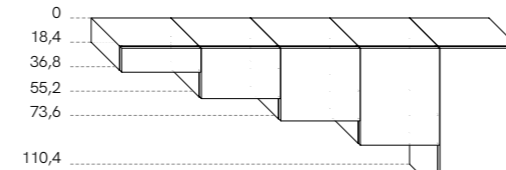

UNOEDUE

Pensili

Wall units

P.32,4

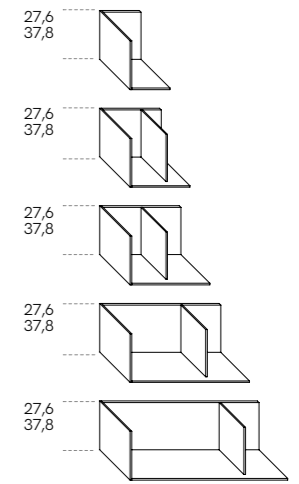
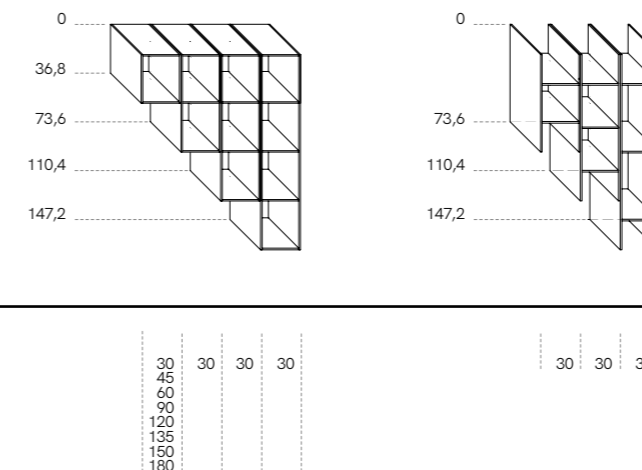

Libreria a spalla
Shelving system bookcase

FREESPACE

A TERRA
FLOOR-LEVEL

P.30 - 42,8

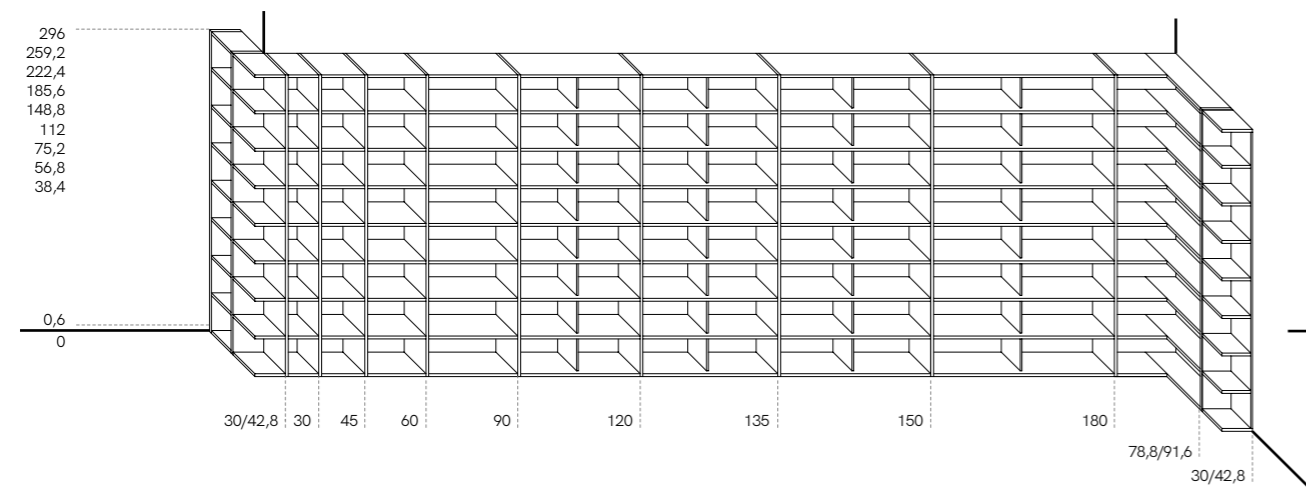

SOSPESA
WALL-HUNG

P.30 - 42,8

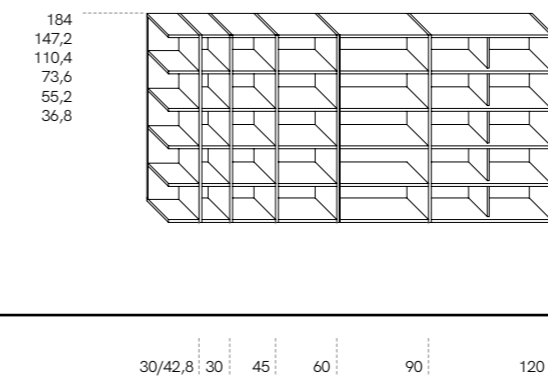

SOSPESA CON RIPIANO USO TOP
WALL-HUNG WITH SHELF USED AS A TOP

P.30 - 42,8

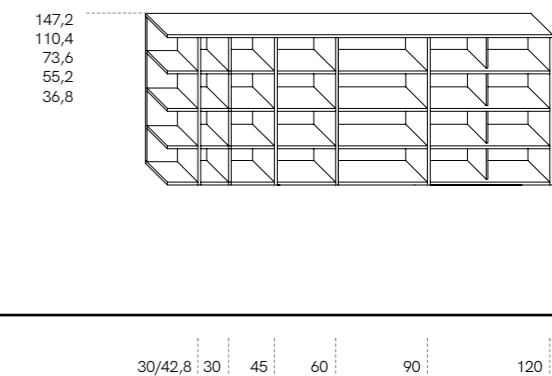

Libreria
Bookcase

WINDY

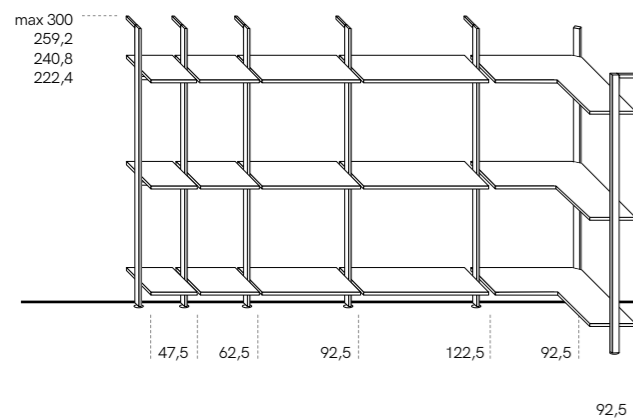

FLEXY EASY

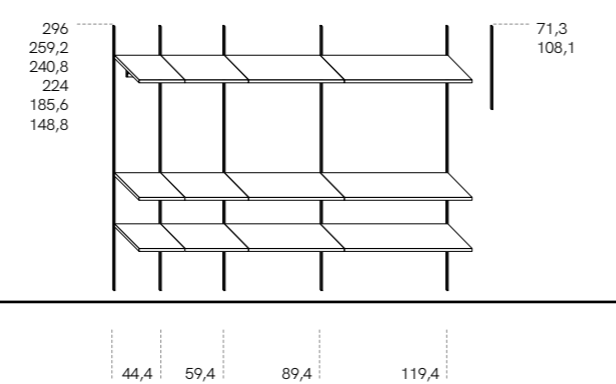

Pannellatura boiserie
Wall panelling

MODULOR

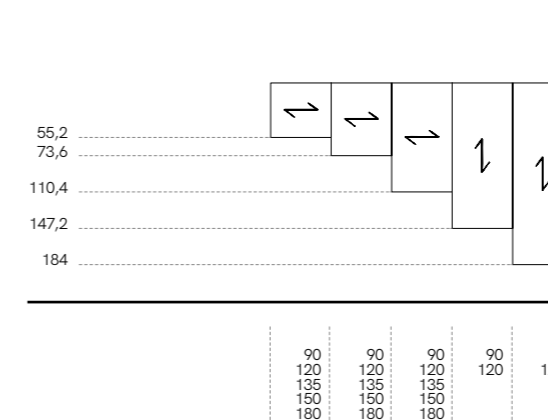

Pannelli tessili
Fabric panels

LABYRINTH

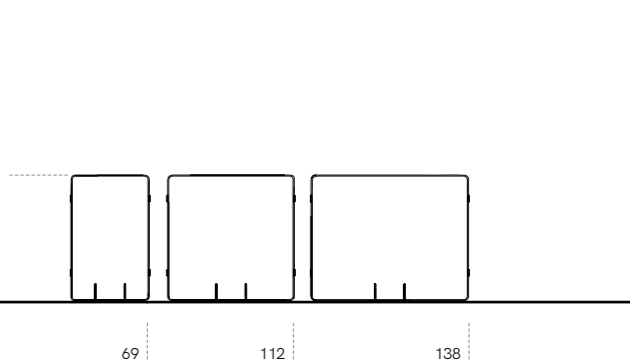

Arrangements and Sizes

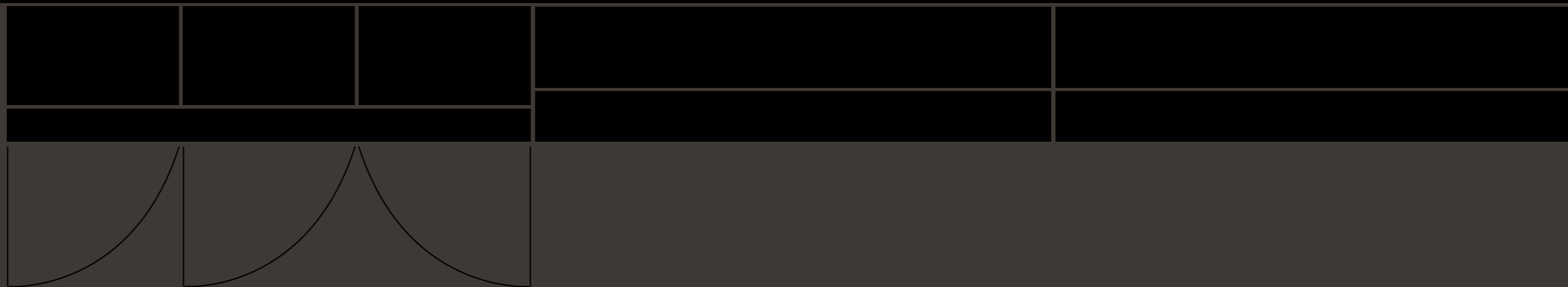
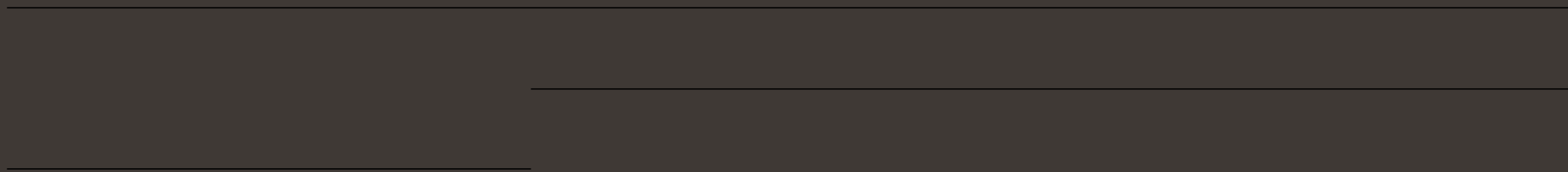



SM2514

P.12

1. Pensili Pensili L.60 H.55,2 anta City Glass brunito vetro trasparente fumé, struttura noce ripiani interni in vetro **2. Basi contenitori** Basi a terra L.150 H.36,8 piano top e copri fianchi sp.1,2 noce **3. Mensole in metallo** L.180 cm brunito **4. Scrittoio** L.180 P.42,8 noce **Modulor 5a.** Pannello L.120 H.147,2 opus cemento **5b.** Pannello L.180 H.110,4 noce **5c.** Pannello L.180 H.110,4 opus cemento **Freespace 6a.** Modulo a terra L.57,2 anta Gola opus cemento con nicchia noce e ripiani in vetro **6b.** Modulo a terra L.57,2 H.296 anta Gola opus cemento

1. Wall units Wall units W.60 H.55.2 with City Glass doors in fumé transparent glass with a burnished frame, walnut structure, internal glass shelves **2. Base storage units** Floor-level base units W.150 H.36.8, walnut top and 1.2 cm thick finishing side panels **3. Burnished metal shelves** L.180 **4. Walnut desk** W.180 D.42.8 **Modulor 5a.** Opus concrete panel W.120 H.147.2 **5b.** Walnut panel W.180 H.110.4 **5c.** Opus concrete panel W.180 H.110.4 **Freespace 6a.** Floor-level module W.57.2 with opus concrete Gola doors with walnut niche and glass shelves **6b.** Floor-level module W.57.2 H.296 with opus concrete Gola doors

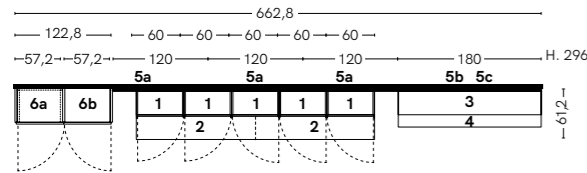

SM2521

P.18

1. Modulor Pannello L.180 H.110,4 rovere natural **2. Pensili Unoedue** Pensile a giorno L.180 P.32,4 H.36,8 opus calce **3. Pensile** Pensile contenitore L.90 P.32,4 H.110,4 opus calce, anta City Glass brunito e vetro trasparente cannettato **4. Basi in appoggio Unoedue** Base in appoggio a giorno L.60 P.45,5 H.18,4 noce con top sp.1,2 cm rovere natural **Base sospesa 5a.** Base sospesa ribalta anta Plana push&pull L.60 P.45,5 H.36,8 **5b.** Base sospesa ribalta anta Plana pus&pull L.60 P.45,5 H.18,4 **5c.** Base sospesa ribalta anta Plana push&pull L.180 P.45,5 H.36,8 **5d.** Base sospesa ribalta anta Plana pus&pull L.90 P.45,5 H.36,8 piano top sp.1,2 cm opus calce

1. Modulor Natural oak panel W.180 H.110.4 **2. Unoedue wall units** Opus lime open wall unit W.180 D.32.4 H.36.8 **3. Wall unit** Opus lime storage wall unit W.90 D.32.4 H.110.4, City Glass doors in transparent fluted glass with a burnished frame **4. Unoedue elevated base units** Walnut open elevated base unit W.60 D.45.5 H.18.4 with 1.2 cm natural oak top **Wall-hung base unit 5a.** Wall-hung base unit with Plana push&pull drop-down door W.60 D.45.5 H.36.8 **5b.** Wall-hung base unit with Plana push&pull drop-down door W.60 D.45.5 H.18.4 **5c.** Wall-hung base unit with Plana push&pull drop-down door W.180 D.45.5 H.36.8 **5d.** Wall-hung base unit with Plana push&pull drop-down door W.180 D.45.5 H.18.4, 1.2 cm thick opus lime top

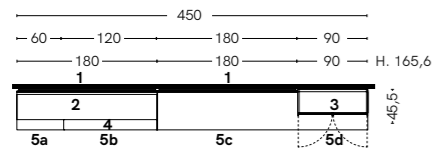

SM2225

P.22

Modulor 1a. Pannelli carbone: pannello L.180 H.55,2; pannello L.180 H.110,4; pannello L.180 H.73,6 **1b.** Pensili anta battente City Glass brunito vetro trasparente fumé H.55,2 L.60 struttura pomice **1c.** Base sospesa anta ribalta Plana push&pull H.36,8 P.45,5 noce piano top sp.1,2 cm noce **1d.** Mensole in metallo brunito L.180 P.25 **2. Base sospesa** Basi sospese anta ribalta Plana push&pull L.180 H.27,6 P.45,5 noce con piano top sp.1,2 cm noce **3. Unoedue** Basi sospese a giorno L.90 P.45,5 noce piano top sp.1,2 cm noce

Modulor 1a. Coal panels: panel W.180 H.55.2; panel W.180 H.110.4; panel W.180 H.73.6 **1b.** Wall units with City Glass hinged doors in fumé transparent glass with burnished frames H.55.2 W.60 and pumice carcass **1c.** Wall-hung base unit with push&pull drop-down Plana doors in walnut H.36.8 D.45.5 with 1.2 cm thick walnut top **1d.** Shelves in burnished metal L.180 D.25 **2. Wall-hung base unit** Wall-hung base units with push&pull drop-down Plana doors W.180 H.27.6 D.45.5 in walnut W.180 H.27.6 D.45.5 with 1.2 cm thick walnut top **3. Unoedue** Open wall-hung base units W.90 D.45.5 in walnut; 1.2 cm thick walnut top

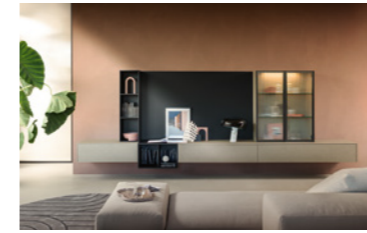
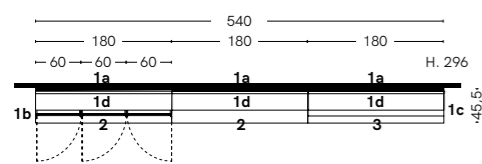

SM2502

P.26

1. Modulor Pannello L.180 H.110,4 cm carbone **2. Pensili Unoedue** Pensile a giorno L.30 P.32,4 H.110,4 carbone **3. Basi sospese Unoedue** Base sospesa a giorno L.60 P.45,5 H.36,8 con top sp.1,2 cm carbone **Basi sospese 4a.** Base sospesa ribalta Plana push&pull L.90 P.45,5 H.27,6 cm **4b.** Base sospesa ribalta Plana push&pull L.120 P.45,5 H.27,6 **4c.** Base sospesa ribalta Plana push&pull L.150 P.45,5 H.27,6 Top e copri fianchi sp.1,2 cm opus cemento **5. Pensili** Pensile contenitore L.90 P.32,4 H.110,4 opus cemento, anta City Glass brunito e vetro trasparente cannettato

1. Modulor Coal panel W.180 H.110.4 cm **2. Unoedue Wall units** Coal open wall unit W.30 D.32.4 H.110.4 **3. Unoedue wall-hung base units** Open wall-hung base unit W.60 D.45.5 H.36.8 cm with 1.2 cm thick coal top **Wall-hung base units 4a.** Wall-hung base unit with Plana push&pull drop-down door W.90 D.45.5 H.27.6 **4b.** Wall-hung base unit with Plana push&pull drop-down door W.120 D.45.5 H.27.6 **4c.** Wall-hung base unit with Plana push&pull drop-down door W.150 D.45.5 H.27.6, 1.2 cm thick opus concrete top and finishing side panels **5. Wall Units** Opus concrete storage wall unit W.90 P.32.4 H.110.4, City Glass doors in transparent fluted glass with a burnished frame

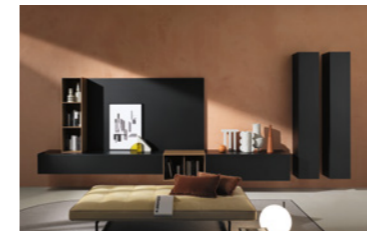
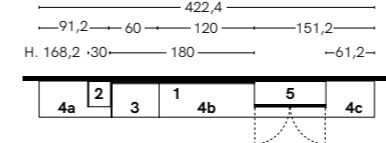

SM2203

P.32

Unoedue 1a. Pensile a giorno H.110,4 L.30 P.32,4 noce **1b.** Base sospesa a giorno H.36,8 L.60 P.45,5 noce con top sp.1,2 cm noce **Basi sospese 2a.** Base sospesa anta ribalta Plana push&pull H.27,6 L.180 P.45,5 carbone con top sp.1,2 cm carbone **2b.** Base sospesa anta ribalta Plana push&pull H.36,8 L.120 P.45,5 carbone con top sp.1,2 cm carbone **3. Pensili** Pensile anta battente Plana push&pull H.184 L.30 P.32,4 carbone **4. Modulor** Pannello L.180 H.110,4 carbone

Unoedue 1a. Open wall unit H.110.4 W.30 D.32.4 in walnut **1b.** Open wall-hung base unit H.36.8 W.60 D.45.5 in walnut with 1.2 cm thick walnut top **Wall-hung base units 2a.** Wall-hung base unit with Plana push&pull drop-down door H.27.6 W.180 D.45.5 in coal with 1.2 cm thick coal top **2b.** Wall-hung base unit with Plana push&pull drop-down door H.36.8 W.120 D.45.5 in coal with 1.2 cm thick coal top **3. Wall units** Wall unit with Plana push&pull hinged door H.184 W.30 D.32.4 in coal **4. Modulor** Panel W.180 H.110.4 in coal

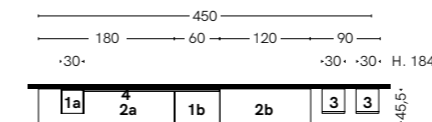

SM2520

P.38

Freespace 1a. Modulo sospeso L.57,2 H.147,2 anta Plana push&pull **1b.** Modulo sospeso L.27,2 H.147,2 **1c.** Modulo sospeso porta TV L.177,2 H.147,2 **1d.** Modulo sospeso L.57,2 H.147,2 anta City Glass brunito vetro trasparente cannettato, struttura noce e schiene opus cemento **Basi a terra 2a.** Base a terra cassettoni Plana push&pull H.27,6 L.90 P.45,5 **2b.** Base a terra ribalta Plana push&pull H.27,6 L.180 P.45,5 **2c.** Base a terra ribalta Plana push&pull L.120 P.45,5 cm H.18,4 Top e copri fianchi sp.1,2 cm opus cemento **3. Vassoio** L.120 H.10,4 Sp.1,2 cm noce

Freespace 1a. Wall-hung module W.57.2 H.147.2 with Plana push&pull doors **1b.** Wall-hung module W.27.2 H.147.2 **1c.** Wall-hung TV module W.177.2 H.147.2 **1d.** Wall-hung module W.57.2 H.147.2 with City Glass doors in transparent fluted glass with a burnished frame, walnut structure and opus concrete back panels **Floor-level Base Units 2a.** Floor-level base unit with deep drawer, Plana push&pull doors W.90 D.45.5, H.27.6 **2b.** Floor-level base unit with Plana push&pull doors W.180 D.45.5, H.27.6 **2c.** Floor-level base unit with Plana push&pull drop-down doors W.120 D.45.5 H.18.4 cm, 1.2 cm thick opus concrete top and finishing side panels **3. Walnut tray** W.120 H.10.4, 1.2 cm thick

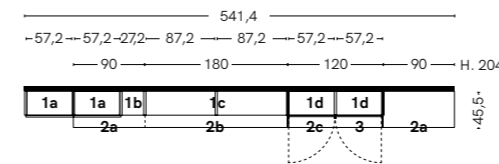



SM2212

P.42

Freospace 1a. Modulo sospeso L.87,2 H.147,2 carbone e ottanio anta City Glass brunito vetro trasparente **1b.** Modulo sospeso porta TV L.177,2 H.147,2 carbone e ottanio **1c.** Modulo sospeso L.117,2 H.147,2 carbone e ottanio **1d.** Scrivitoio sospeso L.117,2 P. 45,5 carbone

Freospace 1a. Wall-hung module W.87.2 H.147.2 in coal and octane with City Glass doors featuring transparent glass and burnished frames **1b.** Wall-hung TV module W.177.2 H.147.2 in coal and octane **1c.** Wall-hung module W.177.2 H.147.2 in coal and octane **1d.** Floating desk W.117.2 D.45.5 in coal

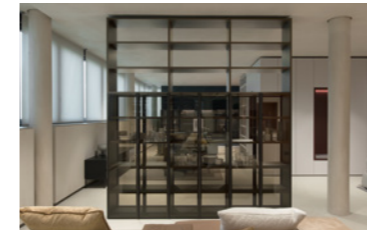
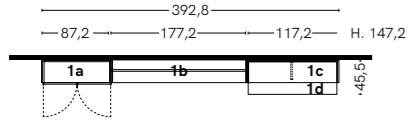

SM2200

P.54

Freospace Moduli a terra bifacciali L.87,2 anta City Glass brunito e vetro trasparente fumé **Freospace** Double-sided floor-level modules W.87.2 with City Glass doors featuring fumé transparent glass and burnished frames

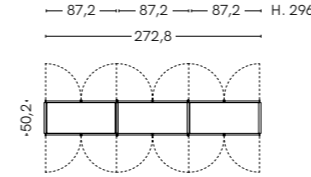

SM2522

P.46

Freospace 1a. Moduli a terra monofacciali L.87,2 P.46,5 H.259,2 anta City Glass brunito e vetro trasparente cannettato **1b.** Moduli a terra monofacciali L.87,2 P.42,8 H.259,2 con ripiani discontinui bianco talco

Freospace 1a. Single-sided floor-level modules W.87.2 D.46.5 H.259.2 with City Glass doors in transparent fluted glass with a burnished frame **1b.** Single-sided floor-level modules W.87.2 D.42.8 H.259.2 with talc white discontinuous shelves

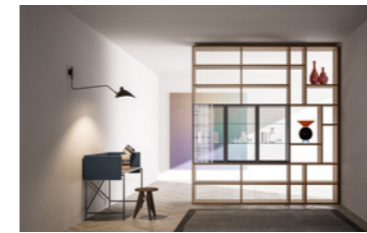
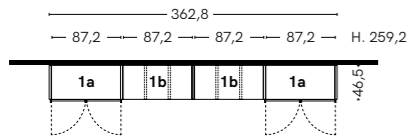

SM2222

P.58

Freospace 1a. Modulo a terra bifacciale con ante City Glass brunito vetro trasparente fumé L.177,2 P.50,2 noce **1b.** Modulo a terra bifacciale L.82,2 P.42,8 noce **2. Sign** Scrivitoio struttura in metallo brunito, piano in melaminico noce

Freospace 1a. Walnut, double-sided, floor-level module with City Glass doors in fumé transparent glass with burnished frames W.177.2 D.50.2 **1b.** Double-sided floor-level module W.82.2 D.42.8 in walnut **2. Sign** Desk with a burnished metal structure and a walnut melamine top

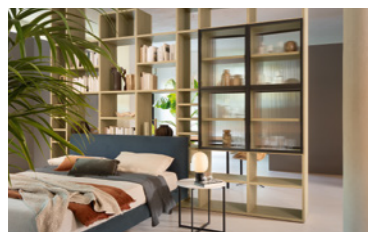
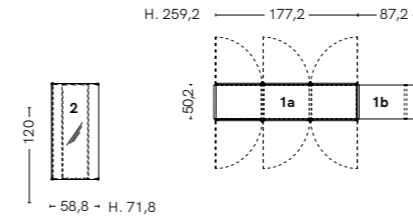

SM2501

P.50

Freospace 1a. Modulo a terra bifacciale L.27,2 **1b.** Modulo a terra bifacciale L.177,2 con ripiani discontinui **1c.** Modulo a terra bifacciale con ante City Glass brunito vetro trasparente cannettato L.57,2 P.50,2 H.296 rovere natural

Freospace 1a. Freespace 1a. Double-sided floor-level module W.27.2 **1b.** Double-sided floor-level module W.177.2 with discontinuous shelves **1c.** Natural oak double-sided floor-level module with City Glass doors in transparent fluted glass with a burnished frame W.57.2 D.50.2 H.296

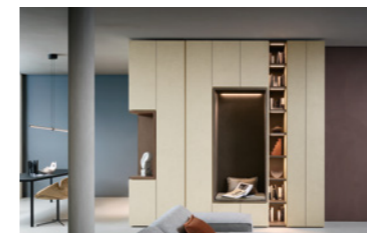
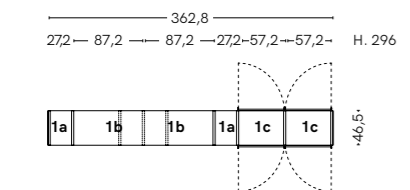

SM2503

P.62

Freospace 1a. Modulo a terra L.57,2 cm nicchia con specchio opus mattone **1b.** Modulo a terra L.57,2 anta Gola opus calce **1c.** Modulo a terra L.57,2 opus mattone ante City Glass vetro trasparente cannettato **1d.** Modulo a terra angolo aperto L.40 P.42,8 nicchia ad angolo opus mattone **1e.** Modulo a terra L.87,2 anta Gola opus calce **1f.** Modulo a terra L.87,2 anta Plana push&pull opus calce, nicchia con seduta opus mattone, cuscino Creta C1F **1g.** Modulo a terra L.27,2 opus mattone **1h.** Modulo a terra L.27,2 opus calce anta Plana push&pull **1i.** Modulo terminale opus calce con anta Plana senza maniglia

Freospace 1a. Floor-level module W.57.2 cm, opus brick niche with mirror **1b.** Floor-level module W.57.2 with opus lime Gola doors **1c.** Opus brick floor-level module W.57.2 with City Glass doors in transparent fluted glass **1d.** Open-corner floor-level module W.40 D.42.8, opus brick corner niche **1e.** Floor-level module W.87.2 with opus lime Gola doors **1f.** Floor-level module W.87.2 with opus lime Plana push&pull door, opus brick niche with seat, Creta C1F cushion **1g.** Opus brick floor-level module W.27.2 **1h.** Opus lime floor-level module W.27.2 with Plana push&pull door **1i.** Opus lime end module with Plana door without a handle

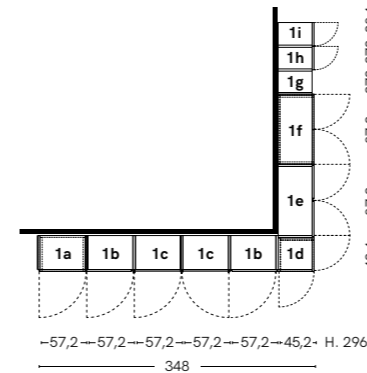



SM2224

P.72

Windy Sistema con palo a soffitto: pali, reggimensole e appendiabiti brunito, mensole sp.2,8 cm carbone, contenitori anta ribalta Plana push&pull noce, contenitori anta vasistas City Glass noce, vetro trasparente fumé e telaio brunito; pannello Siparium tessuto Smack S03 con sacca porta oggetti tessuto Creta C07, scrittoio noce

Windy System with floor-to-ceiling poles: burnished poles, shelf brackets and hanging rails, 2.8 cm thick coal shelves, walnut units with Plana push&pull drop-down doors, walnut units with City Glass lift-up doors in fumé transparent glass with a burnished frame; Siparium panel upholstered in Smack S03 fabric with Creta C07 fabric hanging organisers; walnut desk

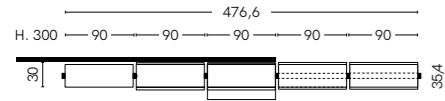

SM2205

P.82

1. Flexy Easy Sistema a cremagliera: montanti e reggimensole brunito, mensole cashmere, contenitori anta vasistas Plana push&pull cashmere **2. Sign** Scrittoio struttura in metallo brunito, piano in vetro brunito opaco

1. Flexy Easy Rack system: burnished metal parts and shelf brackets, cashmere shelves, cashmere units with Plana push&pull lift-up doors **2. Sign** desk with a burnished metal structure and a matt burnished glass top

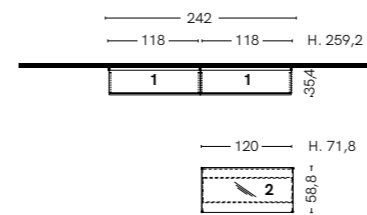

SM2103

P.76

Windy Sistema con palo a parete: pali, reggimensole e appendiabiti brunito, mensole sp.2,8 cm ardesia; contenitori anta vasistas Plana push&pull ardesia

Windy System with floor-to-wall poles: burnished poles, shelf brackets and hanging rails, 2.8 cm thick slate shelves; slate units with Plana push&pull lift-up doors

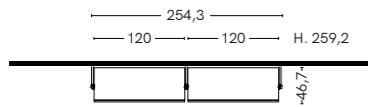

SM2006

P.84

Flexy Easy Sistema a cremagliera: montanti e reggimensole brunito, mensole ottanio **Flexy Easy** Rack system: burnished metal parts and shelf brackets, octane shelves

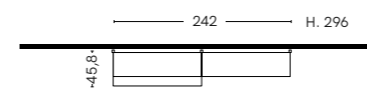

SM2003

P.78

Windy Sistema con palo a parete: pali e reggimensole brunito, ripiani Trai 45 sp.3,5 cm con telaio in alluminio brunito e vetro trasparente, piano scrittoio sp.5 cm arena

Windy System with floor-to-wall poles: burnished poles and shelf brackets, 3.5 cm thick Trai 45 shelves with burnished aluminium frames and transparent glass. 5 cm thick arena desk

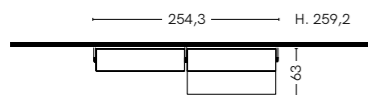

Finishes



Frontali lisci
Plain fronts

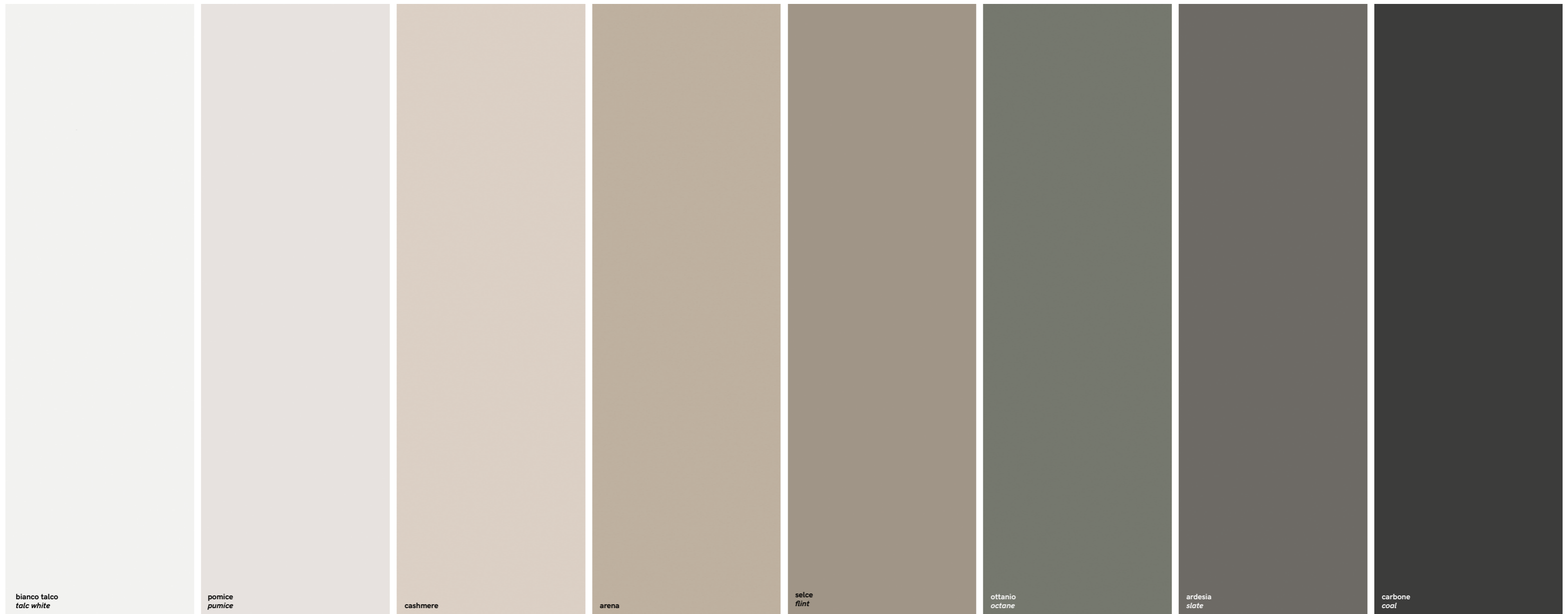

Frontali materici
Textured fronts



* cretto cashmere e cocò disponibili
solo per schiene librerie Freespace
cretto cashmere and cocò are only available
for the back panels of the Freespace bookcase

Frontali vetro Glass fronts

Vetro
ante
City Glass
Glass for
City Glass
doors



Specchio
ante
Glass
Mirror
for Glass
doors



Vetri lucidi
e opachi
ante Glass
Glossy and
matt glass
for Glass
doors

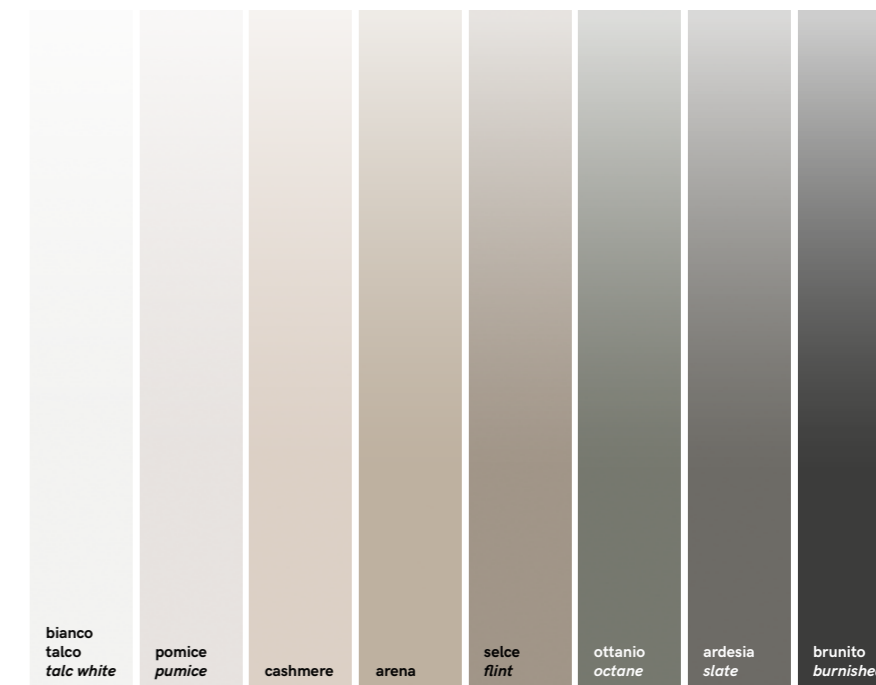

Frontali vetro per chiusure scorrevoli Glass fronts for sliding doors

Vetri
Glass

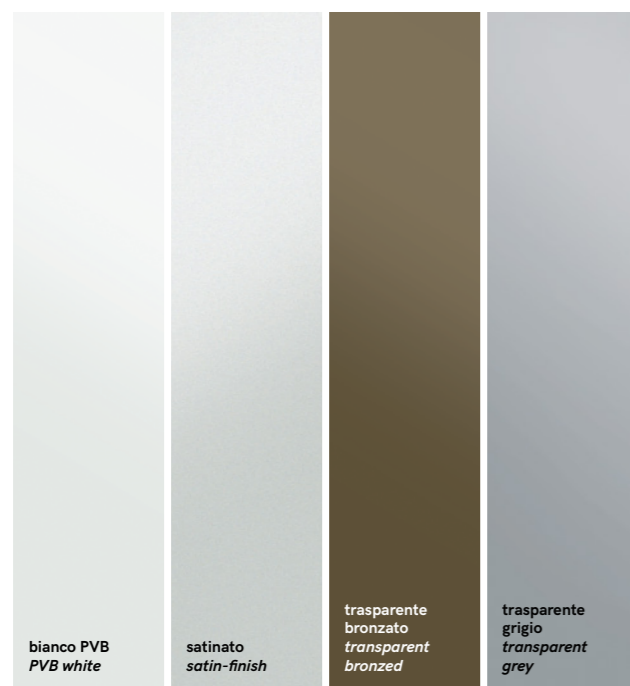

Telai e binari
in alluminio
Frames and
rails in
aluminium



Interno armadi Alterna, scocca e attrezzatura interna Alterna wardrobe interiors, carcasses and interior fittings

Noce *
Walnut *



Sesamo
Sesame



* disponibile solo con esterni noce, bianco talco, pomice, cashmere
available with walnut, talc white, pumice and cashmere exteriors only

Tessuti
Fabrics

Frisby

tessuti
idrorepellenti
waterproof
fabrics

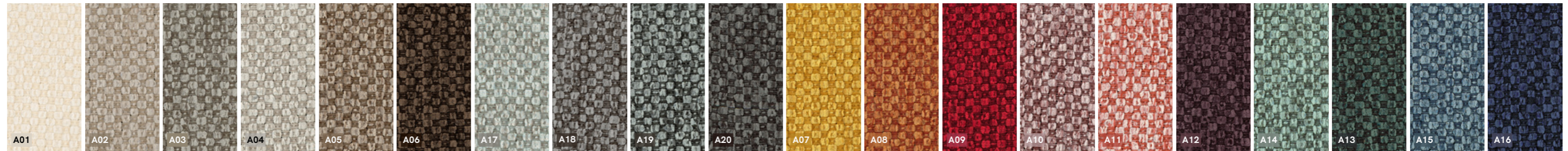

Bloom

ecopelle
eco-leather

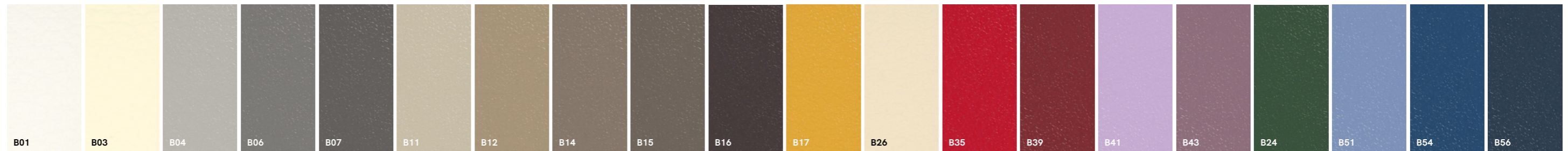

Funny

tessuti
cotone riciclato
recycled cotton
fabrics



Smack

tessuti
antimacchia
anti-stain
fabrics

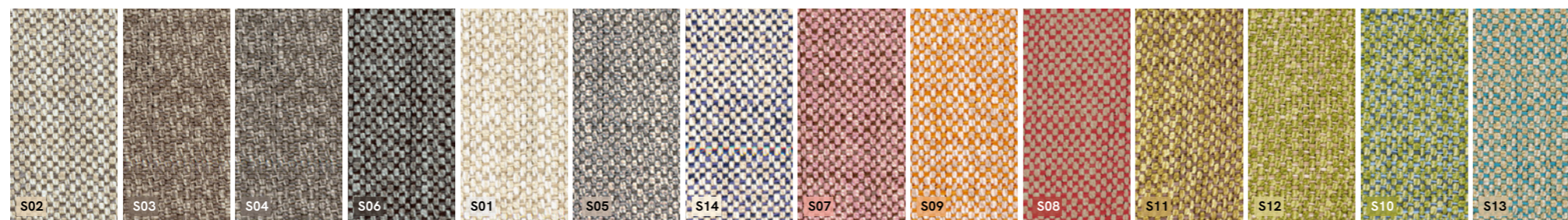

Creta

tessuti
misto lino
linen blend
fabrics

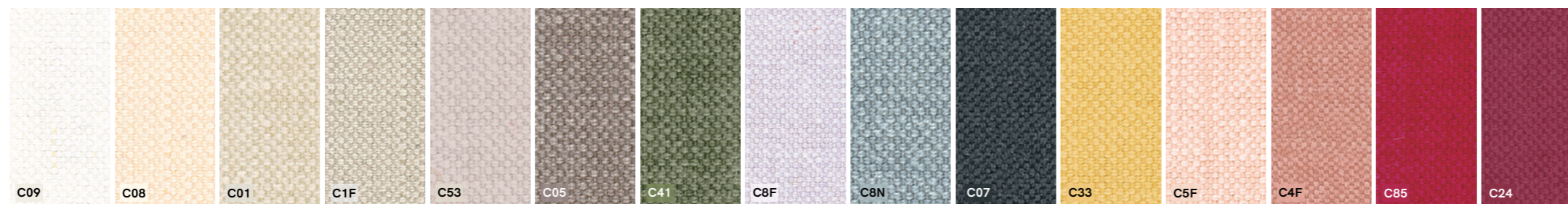

Per i colori, i materiali e gli aspetti tecnici,
fare riferimento ai listini prezzi e relativi aggiornamenti.
For colours, materials and technical specifications
please refer to our price lists and to their updates.

ART DIRECTION
WE ARE DESIGN

PHOTO
Beppe Brancato
Fausto Trevisan

IMAGES
Nudesign

STYLING
Luigina Pilloni
Laura Pasqualato

COLOUR SEPARATION
Nudesign

PRINT
Grafiche Antiga

EDITION
CAT 0125 SD



100% MADE IN ITALY



Via Marosticana, 9
31010 Maser - TV - Italy
Tel. +39 04239255
info@zalf.com



Via Circonvallazione, 21
31020 Falzè di Piave - TV - Italy
Tel. +39 04389861
info@euromobil.com



Via Piave, 25
31028 Tezze di Piave - TV - Italy
Tel. +39 0438 2817
info@desiree.com

gruppoeuromobil.com

ZALF.COM